

Method for determining the composition of airborne particle pollution

**Bryndís Skúladóttir
Arngrímur Thorlacius
Steinar Larssen
Guðmundur G. Bjarnason
Hermann Þórðarson**

Authors: Bryndís Skúladóttir ¹ Arngrímur Thorlacius ¹ Steinar Larssen ² Guðmundur G. Bjarnason ³ Hermann Þórðarson ¹	NORDTEST project number: 1571-02	
	Institution: ¹⁾ IceTec ²⁾ NILU ³⁾ EFA	
Title (English): -		
Title (Original): Method for determining the composition of airborne particle pollution		
Abstract: <p>The objective of the project was to develop a method or measuring process to determine the composition of airborne particulate matter. For this purpose, both physical and chemical analysis were performed and multivariate calculations used to identify or simulate the mass fractions of each source material in real samples of particulate matter. Several source materials were selected, soil, asphalt, soot, brake lining and salt. The method successfully produced estimates for the composition of PM10 winter samples collected in Reykjavik city. Traffic related material is dominating the winter samples but soil, originating from soil erosion, does have a strong impact on the airborne pollution. The average combination for the ambient PM10 samples was found to constitute of asphalt 55%, soil 25%, soot 7%, salt 11% and brake lining around 2%. On the most problematic days when the PM10 concentrations in ambient air are above limit values set in regulations, asphalt is almost 60% of the total PM. Soil and asphalt are seen in higher concentrations in coarse fraction, PM2,5-10 while soot is detected in larger amount in the fine fraction, PM2,5. A comparison between wet and dry days indicates that asphalt is strongly dominating dry days while soot and salt are seen in fairly high concentrations on wet days. There is an indication for a source of PM in summers that is not detectable by the source samples used in this modelling. It is suggested here that pollen and spores might be relevant sources not taken into account in the modelling at hand.</p>		
Technical Group: Expert Group Life Science and Biotechnology		
ISSN: 0283-7234	Language: English	Pages: 53
Class (UDC): 551.510.4	Key words: pollution, airborne particle, asphalt, soil, soot, method	
Distributed by: NORDTEST Tekniikantie 12 FIN-02150 ESPOO Finland	Publication code:	
	Report Internet address: http://www.nordtest.org/register/techn/tlibrary/tec544pdf	

Summary

The objective of the project was to develop a method or measuring process to determine the composition of airborne particulate matter. For this purpose, both physical and chemical analysis were performed and multivariate calculations used to identify or simulate the mass fractions of each source material in real samples of particulate matter. Several source materials were selected, soil, asphalt, soot, brake lining and salt. The method successfully produced estimates for the composition of PM10 winter samples collected in Reykjavik city. Traffic related material is dominating the winter samples but soil, originating from soil erosion, does have a strong impact on the airborne pollution. The average combination for the ambient PM10 samples was found to constitute of asphalt 55%, soil 25%, soot 7%, salt 11% and brake lining around 2%. On the most problematic days when the PM10 concentrations in ambient air are above limit values set in regulations, asphalt is almost 60% of the total PM. Soil and asphalt are seen in higher concentrations in coarse fraction, PM2,5-10 while soot is detected in larger amount in the fine fraction, PM2,5. A comparison between wet and dry days indicates that asphalt is strongly dominating dry days while soot and salt are seen in fairly high concentrations on wet days. There is an indication for a source of PM in summers that is not detectable by the source samples used in this modelling. It is suggested here that pollen and spores might be relevant sources not taken into account in the modelling at hand.

The project is a cooperation between IceTec in Reykjavik, Environment and Food Agency of Iceland (EFA) and NILU in Oslo. A steering group was formed with following representatives;

Bryndís Skúladóttir, IceTec, project leader

Steinar Larssen, NILU

Guðmundur G. Bjarnason, Environment and Food Agency of Iceland

Birna Hallsdóttir, Environment and Food Agency of Iceland

Lúðvík Gústafsson, City of Reykjavik - Office for the Environment

Ásdís E. Guðmundsdóttir, Icelandic Public Roads Administration

The project was financially supported by NordTest, Icelandic Public Roads Administration and City of Reykjavik - Office for the Environment.

Table of Contents

<i>Summary</i>	<u>1</u>
<i>Introduction</i>	<u>3</u>
Background	<u>3</u>
Objective	<u>3</u>
Regulatory status	<u>3</u>
Particle pollution measurements in Reykjavik	<u>6</u>
Earlier studies on Reykjavik air quality	<u>6</u>
Particle pollution in Reykjavik area	<u>7</u>
<i>Methods</i>	<u>11</u>
Description of work	<u>11</u>
Analytical methods	<u>11</u>
Multivariate modelling	<u>16</u>
Collection of ambient samples	<u>17</u>
Selection of source materials	<u>20</u>
<i>Results</i>	<u>25</u>
Weather	<u>25</u>
Analytical results	<u>26</u>
Multivariate modelling	<u>26</u>
Predicted composition of PM in ambient air pollution	<u>27</u>
<i>Discussion</i>	<u>33</u>
<i>References</i>	<u>36</u>
<i>List of abbreviations</i>	<u>37</u>
<i>Annex I - PM10 concentrations Miklatorg January 1999 - July 2002</i>	<u>38</u>
<i>Annex II - Weather data for the selected days</i>	<u>40</u>
<i>Annex III - Results from ICP-OES and ICP-MS analysis</i>	<u>47</u>
<i>Annex IV - Results from statistical analysis</i>	<u>49</u>

Introduction

Background

Air pollution is regarded as an important source of health problems related to pollution. A major part of the pollution is due to increasing traffic, entailing problems related to airborne particles. In Reykjavik the EU limit values for ambient particle pollution are exceeded on several occasions each year. With regulations becoming gradually more stringent it is foreseen that in the nearest future the particle concentration in Reykjavik will exceed the limit values set in regulations. In Iceland there are other sources of particulate matter than traffic, such as soil erosion, street salting in winter and sea salt. Even traffic related sources are more than one, such as exhaust gases and asphalt erosion due to use of studded tyres. This project is aimed at gaining a better understanding of the composition of the particulate matter. In Norway great effort has been put into studies aiming at airborne particles but in Iceland little information is available. In this study the two countries pull together and try a new approach to this problem.

Objective

This project aims at developing a method or measuring process where measurements of samples of ambient airborne particles as well as samples of suspected source materials, are used to determine the mass fractions of the ambient air pollution samples originating from the different sources. The process involves both physical and chemical analysis and multivariable calculations.

Regulatory status

Icelandic regulations on air quality are in accordance with EC legislation. In table 1 relevant regulations and directives are listed.

The general aim of Directive 96/62/EC is to define the basic principles of a common strategy to define and establish objectives for ambient air quality and to assess the ambient air quality in Member States on the basis of common methods and criteria. Also to obtain adequate information on ambient air quality and ensure that it is made available to the public and maintain ambient air quality where it is good and improve it in other cases. This is a framework directive and the limit values for air quality are set in the daughter directives, see table 1.

The objectives of the first daughter directive, nr. 1999/30/EC, is to establish limit values for concentrations of sulphur dioxide, nitrogen dioxide and oxides of nitrogen, particulate matter and lead in ambient air intended to avoid, prevent or reduce harmful effects on human health and the environment as a whole. In Directive 2002/3/EC there are limit values on air pollution by ozone and Directive 2000/69/EC is relating to limit values for benzene and carbon monoxide in ambient air

Directives 70/220/EEC and 88/77/EEC relate to emissions from vehicles.

Table 1. Icelandic regulation on air quality and corresponding EC directives.

Icelandic regulation	EC directive
Reglugerð 787/1999 um loftgæði	Council Directive 96/62/EC of 27 September 1996 on ambient air quality assessment and management
Reglugerð 521/2002 um brennisteinsdíoxíð, köfnunarefnisdíoxíð og köfnunarefnisoxíð, bensen, kolsýring, svifryk og blý í andrúmsloftinu og upplýsingar til almennings.	<p>Directive 2000/69/EC of the European Parliament and of the Council of 16 November 2000 relating to limit values for benzene and carbon monoxide in ambient air</p> <p>Council Directive 1999/30/EC of 22 April 1999 relating to limit values for sulphur dioxide, nitrogen dioxide and oxides of nitrogen, particulate matter and lead in ambient air</p>
Reglugerð 745/2003 um styrk ósons við yfirborð jarðar	Council Directive 2002/3/EC of 12 February 2002 relating to ozone in ambient air
Reglugerð 788/1999 um varnir gegn loftmengun af völdum hreyfanlegra uppsprettna	<p>Council Directive 70/220/EEC of 20 March 1970 on the approximation of the laws of the Member States relating to measures to be taken against air pollution by gases from positive-ignition engines of motor vehicles</p> <p>Council Directive 88/77/EEC of 3 December 1987 on the approximation of the laws of the Member States relating to the measures to be taken against the emission of gaseous pollutants from diesel engines for use in vehicles</p>

In table 2 the limit values for air quality, stated in the above mentioned directives, are given. In the directives an ambitious plan for this decade is set forward. Some of the values are to be reached in year 2001, others in 2005 or 2010. In annexes to the regulation a more detailed description is given for the lowering of the limits for e.g. particulate matter.

Table 2. Limit values for air quality.

	Period	Limit value [$\mu\text{g}/\text{m}^3$] (limit values are not to be exceeded more often than the number indicated in brackets in one calendar year)
Sulphur dioxide:	1 hour	350 (24)*
	24 hours	125 (3)
	Calendar year and winter	20
Nitrogen dioxides (NO_2) oxides of nitrogen (NO_x)	1 hour	200 (18)*
	Calendar year	40* (protection of human health)
Particulate matter (PM)	24 hours	50 (35)* in year 2005 [50 (7) in year 2010]
	Calendar year	40* in year 2005 [20 * in year 2010]
Lead	Calendar year	0,5*
Ozone	8 hour	120** (protection of human health) not to be exceeded on more than 25 days per calendar year averaged over three years.
	May-June	18000 ($\mu\text{g}/\text{m}^3$)-h**, (protection of vegetation) averaged over five years

* For margin of tolerance, see directives

** For further description see directive

Particle pollution measurements in Reykjavik

Air quality monitoring has been practiced in Reykjavik since 1990. Both national and Reykjavik city authorities have an active monitoring program running; Environment and Food Agency of Iceland (EFA) and City of Reykjavik - Office for the Environment (ROE), see table 3.

EFA measurements at Miklatorg, Keldnaholt and Alvidra were running all year round and data is available from 1995 for Miklatorg and from 1999 for Keldnaholt and Alvidra. Some older data with other equipment is available for 1986-1992 from the measuring station at Miklatorg. Miklatorg station was closed down in June 2002 and a station in Grensasvegur serves as the main urban traffic station, operated in cooperation with ROE. Lake Myvatn station was set up in 2000. In 2002 the Alvidra station was closed down. Heavy metals are determined in a collection of dust samples from Miklatorg.

Reykjavik city OE has operated Grensas station since 1993, measuring NO₂, CO, O₃, SO₂ and PM10. In 1998 THC measurements (total hydrocarbon) was added. The station is set at Grensas which is an urban traffic station. For many years the Grensas station was located for 3 months per year at other sites for special projects, usually 2 - 4 weeks at each location. Through the years it has also been located at traffic hot spots, kindergartens, at different suburbs locations. Grensas station serves as the main urban traffic station in Reykjavik from 2002. An urban background station has been running from autumn 2002, in Laugardalur. In addition a portable station is available since 2002, giving data for various locations in the city.

Table 3. Air quality monitoring program in Iceland.

Place	Type of measuring station	Measured components	Period in operation
Miklatorg in Reykjavik	Urban traffic	Heavy metals, PM10, PM2,5	1995 - June 2002
Keldnaholt in Reykjavik	Urban background (border)	NO _x , ozone	1999 -
Grensas	Urban traffic	NO _x , CO, O ₃ , SO ₂ , PM10, PM2,5, THC, BTX	1990 -
Laugardalur	Urban background	NO _x , ozone, PM10, PM2,5	2002 -
Portable station	Variable	NO _x , PM10	2002 -
Alvidra	Rural background	PM10, NO _x	1999 - 2002
At lake Myvatn	Rural background	PM10	2000 -

Earlier studies on Reykjavik air quality

A literature search revealed few recent studies on Reykjavik air quality. A summary of their findings is reported in this chapter.

Thordarson, Y. [1] has done a study on data for particulate matter. The study uses the measurements available and connects them to data on weather, traffic etc. The result

suggest that 50% of the dust is from the roads, asphalt and tires and only 15% from exhaust. This suggestion is based partly on Norwegian findings and it is stressed that further analysing of the samples is needed to improve the data. A correlation was found between rain and dust but not between wind and dust [1].

One study on PAH is available, a student project from May 2001 [2]. The project concentrates on the analytical methods but measured values range from 0,2 to 3 ng/m³ in samples from Reykjavik and Alvidra. Very low values are measured in Vestmanna Islands. The results of the study show that values from Miklartorg are higher than background values but lower than in large cities and that the values are higher for late winter [2].

Reykjavik City OE publishes a report every year with the results from the monitoring program [3] and EFA publishes report on air quality measurements on their website [4]. The data for particulate matter shows that the background value, in measuring station Alvidra, is generally low with occasional exemptions, probably due to earth erosion which is problematic in Iceland. Background values in Alvidra do exceed the EU limit values several times a year (e.g. 3x in 1999). By comparing Alvidra background measuring station with Miklartorg urban traffic station the traffic effect is obvious. The magnitude is increasing in Reykjavik through the years. There is a direct connection between PM measurements and precipitation in Reykjavik. In dry and still winter periods the values are relatively higher than in snowy winters or in rainy autumns. The yearly pattern is that two peaks appear, in autumn (Nov/Des) and in spring (Mars/April). The reasons are believed to be studded tires on ice-free streets in fairly calm and dry weather and possibly a temperature inversion. But it is also a fact that more exhaust particles are emitted from cars in cold weather. Another reason can be that sand and soil/mud erosion can be excessive if snow does not cover the ground and occasionally salt blowing from the sea can be quite intense, [3] and [4].

Particle pollution in Reykjavik area

There is a clear seasonal pattern seen in the results of the PM measurements. In figure 1 it is shown how the particulate matter varies between seasons and the top is reached in the winter time.

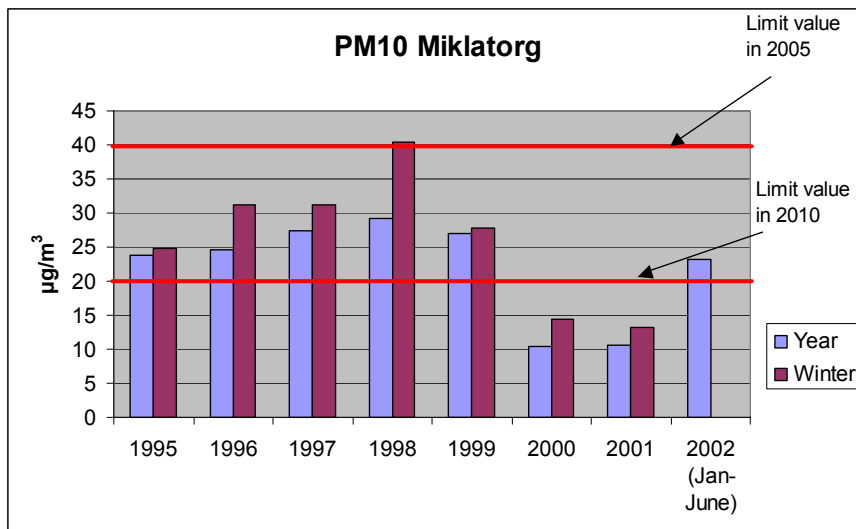

Figure 1. Monthly averages and maximum 24 hour value for PM10 at Miklatorg 2001 [4]

In figure 2 the changes from year to year is shown for 1995 - June 2002. The PM pollution increased steadily from 1995 - 1998 but is there after declining. It is too early to conclude whether the change is only temporary or whether there is a continuing trend towards lower emissions which shows up in the measurements. It should also be noted that in the year 2000 the equipment broke down and few values are behind the average figure. Other measurements in Reykjavik do not give such a low value in year 2000. The average values are below the limits as they were at the time, but in regulation 25/2002 more stringent values are set. The yearly value is to be lowered to $20 \mu\text{g}/\text{m}^3$ in year 2010. It is noteworthy that at an background station, Alvidra, the yearly and winter average is typically between $6,4 - 9,4 \mu\text{g}/\text{m}^3$.

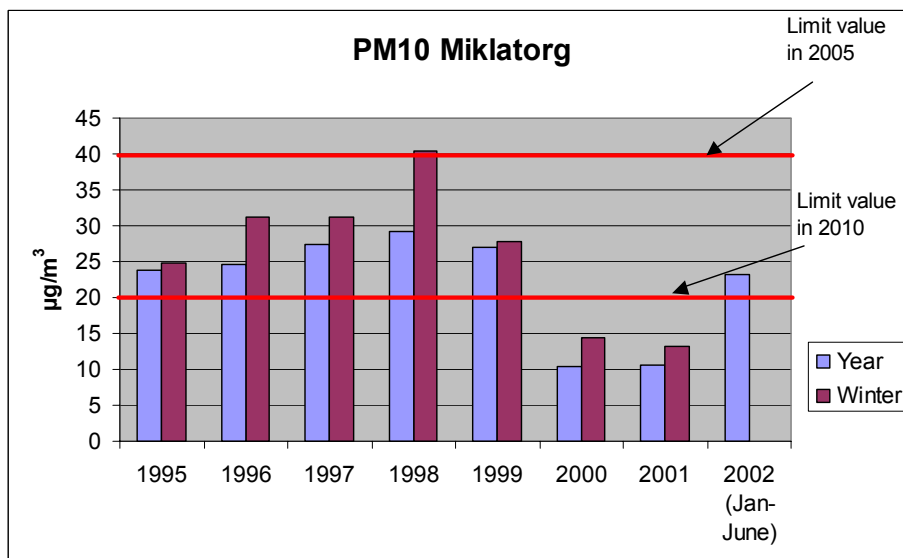

Figure 2. Yearly and winter average for airborne particulate matter at Miklatorg in 1995 - 2001 and the average for Jan - June 2002 [4]

The 24 hour value is to be lowered to $50 \mu\text{g}/\text{m}^3$ in 2010, allowed to be exceeded 7 times. The number of times exceeding this value in recent years is shown in figure 3. These are likely to raise problems in Reykjavik in coming years, especially when taking into account the fact that the measuring was only conducted every other day at the time and in e.g. year 2000 the monitoring was stopped for a while due to brake down.

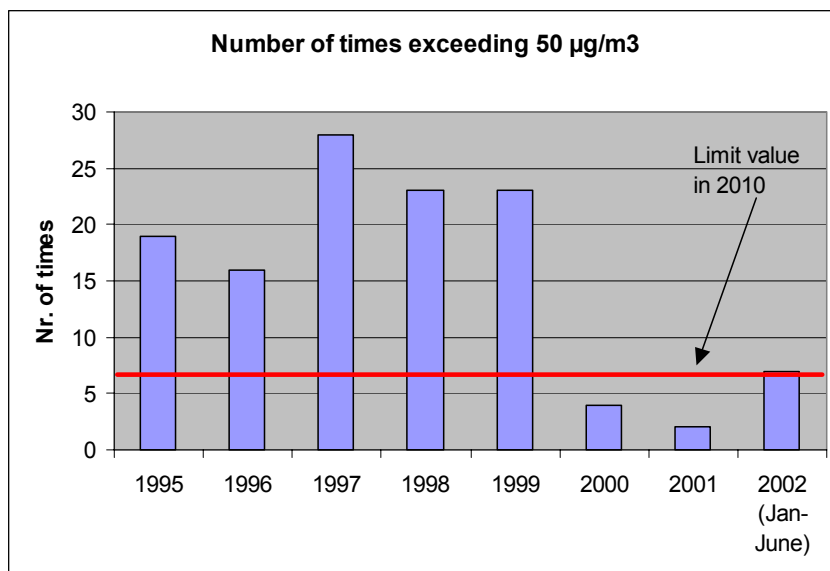

Figure 3. Number of times exceeding the $50 \mu\text{g}/\text{m}^3$ limit. [4]

A daily pattern is seen when looking at the ambient air pollution concentration at different time of day. This can be seen when the average concentration of PM₁₀ and NO_x is plotted against different time of day. In figure 4 this is done for Grensas station (urban traffic station) and in figure 5 this is done for data from the portable station, as the data is divided between urban traffic sites and urban background sites. The pattern indicates a traffic related effect on the pollution level as the concentrations are higher during daytime and fall down during night time. Peaks appear for early morning and afternoon in correlation with traffic peaks. Traffic effect is also seen for NO_x when looking at the difference between concentrations at traffic sites and background sites. This trend is not as strong for dust, as the concentrations for PM₁₀ is similar at traffic and background locations.

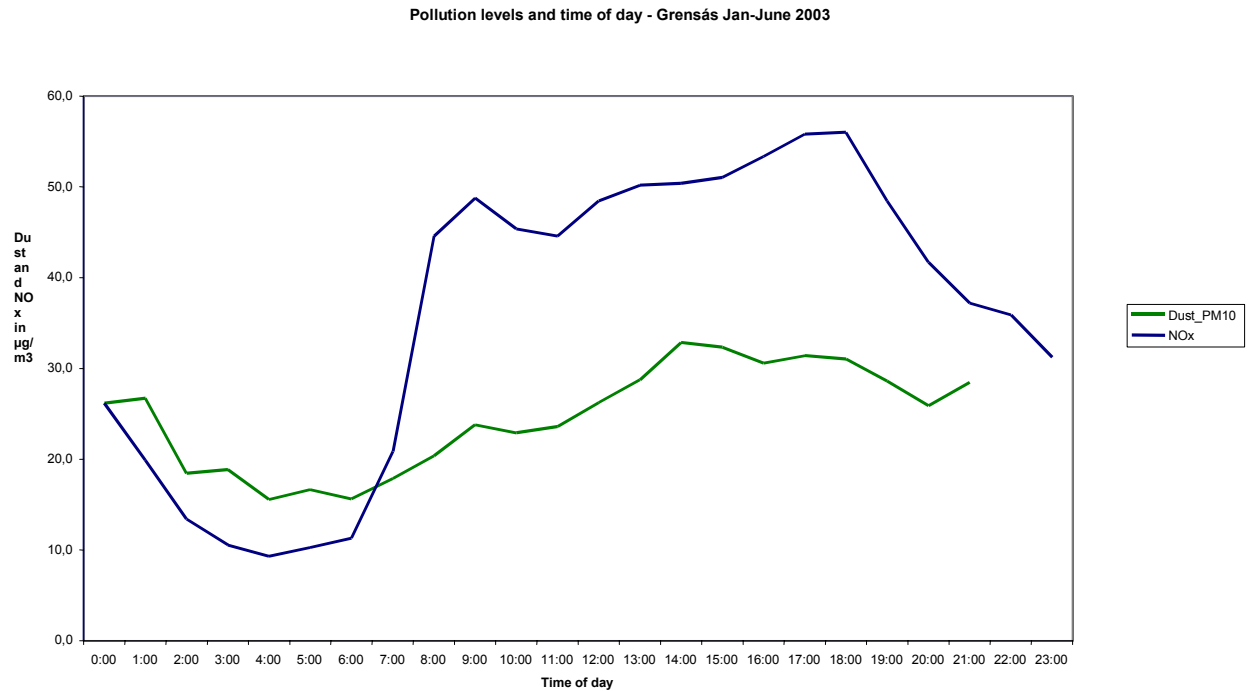

Figure 4. Average concentration of PM₁₀ and NO_x vs. different time of day for the period January - June 2003 at Grensás station [5]

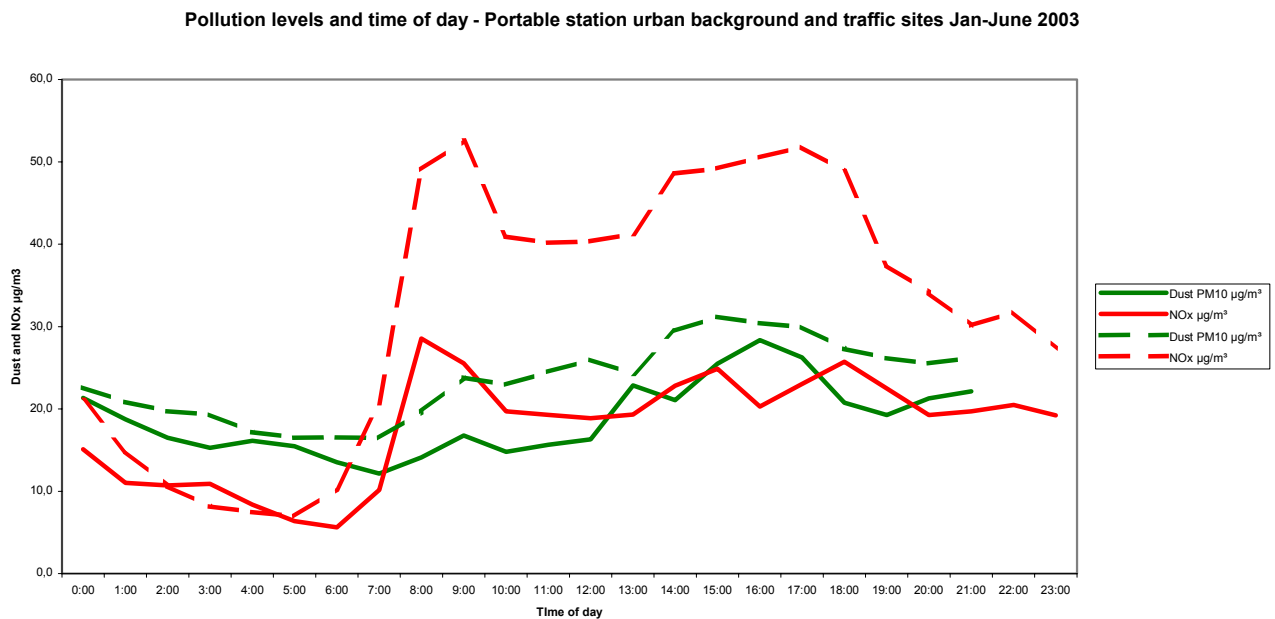

Figure 5. Pollution level at different time of day, data from portable station. Broken lines show values for traffic locations and whole lines values for background locations. Average values for each hour for January - June 2003, PM₁₀ and NO_x. [5]

Methods

Description of work

The objective of this project is to develop a method where a combination of inorganic and non-specific spectrometric analysis followed by multivariate calculations is used to detect the source of different fractions of ambient airborne particle pollution.

The original materials or sources of pollution that were considered are: asphalt, soil, brake lining, car exhaust and sea salt/ street salt. To be able to separate the contribution from these materials one has to use several variables that do not vary in the same manner for any two sources of materials. To assure this, a combination of inorganic analysis and reflectance spectra covering the visible to near-infrared range, was used and thereby a fingerprint for each source material was developed. The reflectance data are expected to add information related to the organic content of the samples. For example it is possible that the main inorganic ingredients in soil and asphalt could be very alike while the organic material in asphalt will primarily be mineral oil fractions, but the soil will mainly contain totally different organic materials like humus and various animal and plant residues. The combination of inorganic and organic information should increase the chance of differentiating between the different source materials by multivariate calculations. The reflectance measurements were chosen for the purpose, as they are non-destructive and thus could be carried out before the destructive digestion of the filters, necessary for the element analysis.

Analytical methods

Inorganic measurements were carried out with ICP and ICP-MS technology. For the organic measurements NIRS (Near Infrared Reflectance Spectroscopy) was used with a wavelength extension, thus covering also the visible range. This technology has not been used in this context before.

Near Infrared Reflectance Spectroscopy (NIRS) is utilised for indirect quantitative analysis of organic constituents. The use is primarily connected to agriculture and food production. The measurement is indirect, meaning that an individual signal response (the reflected light intensity at a certain NIR-wavelength) is not directly related to the concentration of a single chemical substance as is the case in conventional spectrometric analysis. Instead, each NIR signal has contributions from the different chemical constituents of the sample as well as from the texture or surface characteristics. To get useful quantitative information from such data a series of standard samples (spanning the expected range of sample matrices and concentrations for the problem at hand) are thoroughly analysed by traditional chemical or physical techniques and multivariate computations used to establish a mathematical relation between the NIR spectrum of a sample and the corresponding analyte concentrations. NIR measurements are characterized by very good precision and the accuracy is for the most part quite good, but the latter is of course very dependent on the quality of the standardization work. As with traditional IR, NIR spectra are largely produced by the organic constituents of a sample.

The utilization of NIR spectrometry for the present purpose is outside the traditional use of the technique. Here we are not interested in revealing concentrations or even the nature of the different sample components. We merely want to use the spectral data to trace a compound spectrum of contributions from individual source materials, which each and every one has its own more or less complex set of components and corresponding concentrations. The main reason for attempting to use this technique, was a hope to distinguish between samples of asphalt and soil respectively. These might have somewhat similar inorganic content but are expected to have different NIR activities due to differences in the organic content stemming on one hand from petrochemicals but from humic substances and plant debris on the other. Adding the visible range reveals colour differences which may be related to either inorganic or organic constituents of the sample. They should in either case help in differentiating amongst the suspected sources.

Sample preparation

After securing near infrared reflectance data from a sample (particles spread over the surface of a teflon filter membrane) it was transferred to a teflon bomb (Parr Instrument Company, USA) along with 3mL of ultra pure nitric acid (Fluka, Selectipur) and 2mL of a 25% solution of hydrogen peroxide (MERCK, pro analysi). Samples were digested under pressure, by microwave heating in a conventional household oven (Electrolux Heatwave Autocook) capable of stepwise heating, 6 bombs at a time, according to the following heating program.

	Time (min.)	Effect (W)
Step 1	1	450
Step 2	5	150
Step 3	2	450

After digestion the contents of a bomb were filtered through disposable syringe filters (teflon, 0,45 μ m, Watman) and quantitatively transferred to graded polystyren tubes (Sarstedt, Germany) which were then filled to 12mL by ultrapure water). The resulting solution was used directly for ICP-OES determinations but an aliquot was diluted 6 times and used for the ICP-MS analysis. Each portion of samples (each working day) was accompanied by at least one digestion blank (reagents only) and one portion of a standard reference plant material i.e. poplar leaves (GBW 07604, China) that was digested with the same procedure. One blank teflon filter, identical to those used for collecting the dust particles, was also digested.

Quality assurance for the inorganic analytes

The digested solutions of the plant reference material were analysed with both ICP-techniques and the results compared with the certified values. In addition, a river water sample (SLRS-4, NRCC Canada) was measured with the ICP-MS technique. Regarding the ICP-MS work, several results for the river water material were below the corresponding detection limit, but aside from a slightly high Sr measured in the river water (ca. 1.25 times certif.) and low Ti in the poplar leaves (ca. 1/3 of cert.) all quantifiable results for both materials were in acceptable agreement with the certified

values. Regarding the ICP-OES results, Al produced a to low result for the poplar leaves (ca. 1/4 of cert.). The low results for Ti and Al in poplar leaves are probably due to poor dissolution of the plant material as these elements may well be associated with the silicate rest that survives this type of digestion (no HF used). All three analytes (Al, Ti, Sr) were accepted for the multivariate modelling work.

ICP-OES (Inductively Coupled Plasma Optical Emission Spectrometry)

Instrument: Spectroflame D, Spectro Germany.
Plasma: Ar, W, vertical mount
Plasma flow: 15 L /min.
Integration time: 3 x 3 sec. + 3 x 3sec. backgr. correction
Nebuliser: Cross flow, double-pass spray chamber

	wavel. (nm)	ST (mg/L)
Ca	422.673	20
Mg	285.213	20
K	766.491	20
Na	589.592	20
Fe	259.94	20
Mn	257.61	20
Zn	213.856	20
Cu	327.396	20
Al	396.152	20
B	249.773	20
P	213.618	20
S	182.04	20
Si	288.158	20

The ICP responses were quantified by one-point standardisation (blank plus one non-zero standard solution). In the auto-sampler, each series of 11 positions contained one measurement standard and two reagent blanks. The zero concentration level for each analyte, was estimated by linear regression of results for the series of regression blanks. The detection limit was estimated as 3 times the standard deviation for the series of differences between an actual blank reading and the corresponding regression value. Similarly the non-zero standard signal was estimated by linear regression through all the standard readings. This procedure yields drift-corrected results along with estimates for the detection limit for each measurement run. No results are reported for B, S, K and Mn. The results for boron, sulfur, potassium and manganese were omitted due to the large portion of results that were below the estimated detection limits, but the results for silicon were discarded since digestion blanks yielded high and uneven measurements. For the analytes reported, all digestion blanks, as well as the digested teflon filter, produced results below the estimated detection limits. The ICP-OES results are given in Appendix III on a sample weight bases i.e. as percentages of the amount of dust collected.

ICP-MS (Inductively Coupled Plasma Mass Spectrometry)

<i>Instrument:</i>	<i>Leco Renaissance ICP TOF Mass Spectrometer, Leco USA.</i>
<i>Plasma effect:</i>	<i>1200W</i>
<i>Plasma flow rates:</i>	<i>15,5 L/min. (total), 0,98 L/min. (nebuliser), 1,15 L/min. (aux.)</i>
<i>On-line dilution:</i>	<i>ca. 26 times with external peristaltic pump (color coded tubing)</i>
	<i>Sample: orange-yellow</i>
	<i>0.1% HAc: green</i>
	<i>Internal std. mixture: green</i>
<i>Internal st. mix.</i>	<i>25 ppb Sc, 10 ppb Ge, 10 ppb Sb</i>
<i>Integration time</i>	<i>6 x 2 sec.</i>

Analytical isotopes

As-75
Ba-138
Cd-114
Co-59
Cr-53
Cu-65
Hg-202
Nb-93
Ni-62
Pb-208
Sr-88
Ti-49
V-51
Zn-66
Zr-90

Internal standardisation

Ge-74
Sb-121
Sc-45

The procedure for drift correction and estimation of detection limits was identical to the one described above for the ICP-OES determinations. No results were reported for As, Cd, Cr, Hg or Ni since a large portion of results were below only marginally above the detection limits. For all these elements, the highest measured concentration was less than ten times greater than the corresponding detection limit. Zn produced acceptable and comparable results with both ICP techniques. The ICP-OES results were selected for the further work. All analytes were determined with and without internal standardisation, using one or more of the three isotopes stated above. Internal standardisation did not prove to be useful in any case (no improvement in accuracy for the reference materials or stability for the standard samples) and all reported ICP-MS results are obtained with external standardisation. The ICP-OES results are given in Appendix III on a sample weight bases i.e. as ppm of the amount of dust collected.

NIR Spectrometry

Instrument: Foss NIRSystems, Model 6500
Sample cups: Circular, i.d. 38 mm, with quartz windows
Wavelength range I: 400 - 1100 nm (visible)
Wavelength range II: 1100 - 2500 nm (near infrared)
Resolution: 2 nm (both ranges)

The circular sample cups are designed to hold ground feed samples or other pulverised sample materials, which are immobilised within the cup by a cellulose pad. The teflon filter discs have a diameter of 37 mm, thus fitting closely into the cup. They are held in place just behind the quartz window by two rubber o-rings. The first (between quartz window and the filter) is 1.5 mm thick and its function is to keep the dust coating on the teflon surface in close vicinity to the window, yet preventing it from coming in direct contact with its surface. The second o-ring, which is 3 mm thick, holds both the filter and the thinner o-ring in place, thus supporting the whole setup. The teflon filter discs are strengthened by a peripheral band or ring made from plastic. Both this plastic material and the rubber o-ring, touching the window, have reflecting characteristics differing from those of the teflon filter material. To get rid of reflectance from these materials an aluminum shield (made from a disposable aluminum cup) with a circular opening, 28 mm in diameter, was placed on the outside of the window thus leaving a correspondingly wide central portion of the filter open to reflectance measurements. For convenience, two such modified sample cups were used. For each cup a spectra from a blank (unused) teflon filter disc was recorded for reference.

It may be noted here that a reflectance-signal is usually not recorded as the intensity of the light reflected by the sample, I_R , but as $\log[1/I_R]$, a quantity proportional to analyte concentration, analogous to absorbance ($A = \log[I/I_0]$). All NIR data discussed here have been thus transformed. The instrument used, comes with software specifically designed for routine NIR reflectance measurements of pulverized samples. It has a somewhat primitive data-export option, producing "space-separated" ASCII-files with each spectrum (1050 values or data points) patched into lines, 8 points each, separated by "carriage return" and "line break" codes. To make these data sets "edible" for a spread sheet or a statistical software package, a Visual Basic program was designed. This program has a four-fold purpose; i) it removes all explanatory text and typographic codes except for the "space" characters separating the values, ii) it transposes the data set returning each spectrum as a column of values instead of a line, iii) it reduces the size (and the resolution) of the spectra by a factor of five and iv) it separates the visible part and the near-infrared parts into two separate spectra, since there is an "instrumental" discontinuity between the spectral regions produced by the instruments two detectors. The data-reduction is done by calculating new spectral points obtained by 7-point polynomial smoothing around every fifth data point in the original spectra, yielding smoothed spectra with a resolution of 10 nm.

An inherent problem with reflectance spectra is the lack of a suitable zero reference or blank. For conventional quantitative work on pulverised samples, this is solved by filling the sample cups to a degree insuring that no reflectance from the side walls or bottom of the cup will be seen. Thus only the sample itself and the non-

absorbing quartz window are illuminated by incoming radiation. In the present setup, the teflon filter, having a reflectance spectrum of its own, will contribute to the recorded spectra in a varying degree, depending on the amount of particulate material covering its surface. In the present work this was overcome by introducing a shielding factor for the blank or reference signal. The shielding is considered to be additive both regarding different amounts of the same material and regarding contributions from different materials. Thus for a mixture of components, with known background shielding contributions, captured onto the filter surface, each point of the background spectrum is produced by a factor $r < 1$, calculated by the following expression.

$$r = \sum (k_i/m) * x_i$$

where the summation is taken over all values of i from 1 to the number of components. k_i and x_i are the shielding effect by unit mass and the mass fraction, respectively, of component i and m is the total mass of material covering the filter surface. The k_i values for the different source materials were obtained from duplicate or triplicate spectra recorded from filters covered with different amounts of the same material. This was done in a spreadsheet, comparing two blank-corrected spectra by calculating the sum of squares of the differences between all corresponding spectral points. The shielding effect for one spectra was entered manually and the other shielding effect for the other calculated automatically in proportion to the mass ratio of the two samples i.e. 2 mg of dust will reduce the background signal twice as much as 1 mg of the same dust material. The first shielding effect was varied (manually) to minimise the above mentioned sum of squares.

Multivariate modelling

The multivariate technique used for this modelling work is called Partial Least Squares (PLS) Regression. It was developed within the discipline of chemometrics and it has been thoroughly treated in numerous research articles several textbooks including a book by R. Kramer; "Chemometric Techniques for Quantitative Analysis", Marcel Decker, 1999.

Chemometric software: SIRIUS, Pattern Recognition Systems, Norway.

Data pre-treatment: MS Excel, Microsoft, USA.

One PLS model was calculated for each source material. An important modelling feature is the independence of the source materials. When modelling a variable, the model has to yield a value close to 100% for that variable and values close to 0% for all the others. Consequently, the number of source materials was reduced from eight to five during the modelling work as described in the results section below.

In addition to pre-treatment of the analytical results, described below, some weighing (after block-normalization) of individual analytes turned out to be helpful (fewer outlying results and better separation of the source materials).

Pre-treatment of the ICP-OES and ICP-MS results

Both instrumental techniques yield concentrations related to the volume of solution i.e. mg/L and $\mu\text{g/L}$ respectively. To get comparable data the results have to be corrected for

the amount dust collected, to give % or ppm of analyte per mass of dust. Furthermore, for multivariate calculations on concentration data, including both trace and macro constituents, some sort of normalisation is necessary. Here, block normalisation was used, dividing each concentration value by the sum of values obtained for all the samples for the analyte in question.

The element results (ICP-OES and ICP-MS) were pre-screened for feasibility as source-tracking variables. Firstly, all results within +/- the detection limit were replaced by zeros. This is necessary to prevent mere noise from being expressed differently for large and small sample weights. Secondly a variable is only useful if the concentration range for the source samples covers the ranges for the actual dust samples. If an actual sample has a higher concentration of some analyte than the highest concentration for a source sample, one will get a bad fit in the model. From such considerations, some analytes were discarded before the multivariate data treatment.

Pre-treatment of the NIR-reflectance spectra

Even after the data-reduction described above, each NIR spectrum contains more than 200 data points whereas the number of inorganic analytes used in the final modelling steps is only 12. To avoid total dominance of the NIR data in the model, the spectra were further reduced by averaging to 5 NIR-values for each of the spectral ranges yielding 10 NIR-values per sample. The thus obtained NIR points were all divided by the corresponding mass of dust and finally block-normalised as described above.

Improvement of the NIR data by iteration

To be able to estimate the degree of background shielding in the NIR spectra obtained from real samples of air-borne dust, one has to know the relative amount in the dust, of each shielding constituent. Since obtaining such values is the sole purpose of this modelling, an iterative procedure has to be adopted. In short, for the first data set (first attempt on <2.5 μm fraction) all samples were assumed to contain the same amount of shielding constituents namely, 30 % soil, 50 % asphalt, 10 % gasoline soot, and 10 % diesel soot (since the salt content is a calculated variable, no experimental data is available to estimate its shielding effect in real samples). Background-corrected NIR results, based on these concentrations is then entered into the model to produce a new, more realistic, set of concentrations. These are then used to calculate new NIR values to be used in the next round of PLS-modelling and so on. The final modelling result for the <2.5 μm fraction was used as a starting point for the samples containing the coarse particles (<10 μm fraction). The iteration results for the coarse material is shown as an example in appendix V.

Collection of ambient samples

The ambient air pollution samples used in this study derive from the air quality monitoring measurements in 1999 - 2002. They are all collected at the same measuring station, called Miklartorg, see figure 6. Miklartorg is one of the main streets through the city, connecting the west part to the to east part of the city. The measuring station is at an intersection with Bustadavegur, near the centre of the city. Bustadavegur is a main traffic line connecting the surrounding communities south of Reykjavik to the city centre.



Figure 6. EFA measuring station at the intersection of Miklabraut and Bustadarvegur. The street marked with red is Miklabraut. The inserted map shows the location in Reykjavik area.

Traffic counting for this intersection in year 2000 is around 70.000 vehicles per day. (69.432) according to Environmental and Technical Sector of the City of Reykjavik [6]

Weather data for the 30 year period 1961 - 1990 show that the average temperature in Reykjavik is 4,3°C varying between -19,3°C and +24°C. Wind rose for the period is shown in figure 7, indicating that easterly winds are dominating.

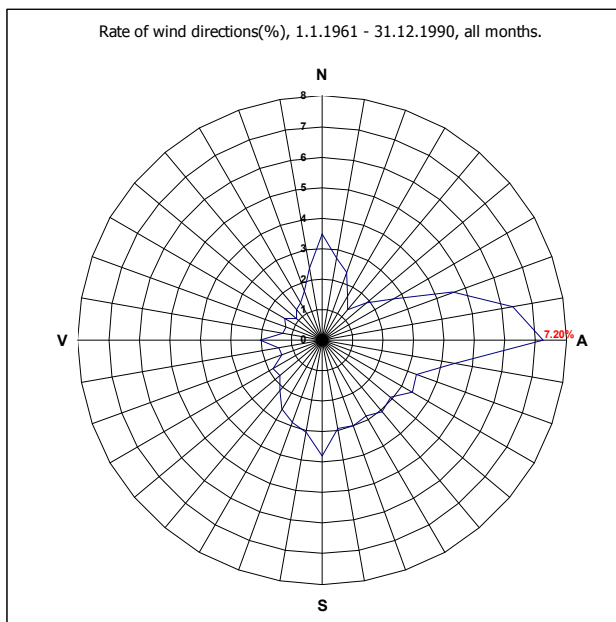

Figure 7. Wind rose for Reykjavik, 1961-1990. Based on [7]

The PM sampling device is a *Sierra Andersen Dichotomous virtual impactor with 10 μ InletTM*. The device samples and size fractionates suspended particles into two size fractions, 2.5 – 10 μ m (PMcoarse) and less than 2.5 μ m (PMfine). The PM is collected on teflon filters. Samples are collected for 24 hours at time every other day. These samples are available from the period of 1998 - June 2002.

For this study two different methods and criteria were used to choose ambient samples. Firstly the ratio between PMfine and PMcoarse was used. In figure 8 a plot of PMfine vs. PMcoarse for measurements from Jan. 1995 – Feb. 2002 is shown. Majority of the measurements falls into the lower left hand corner. Only occasional measurements are exceptional and therefore of interest. It is expected that high concentration values of predominantly fine particles are associated with humid weather conditions and abundant combustion products (filters 1 and 2). While similar concentrations in fine and coarse particles indicate dry conditions with substantial input from combustion (filter 3). Predominantly coarse particles in a sample indicate either dry road surface or the presence of wind blown dust (filters 6-8). This connection with weather condition is supported by Thordarson, Y. [1]

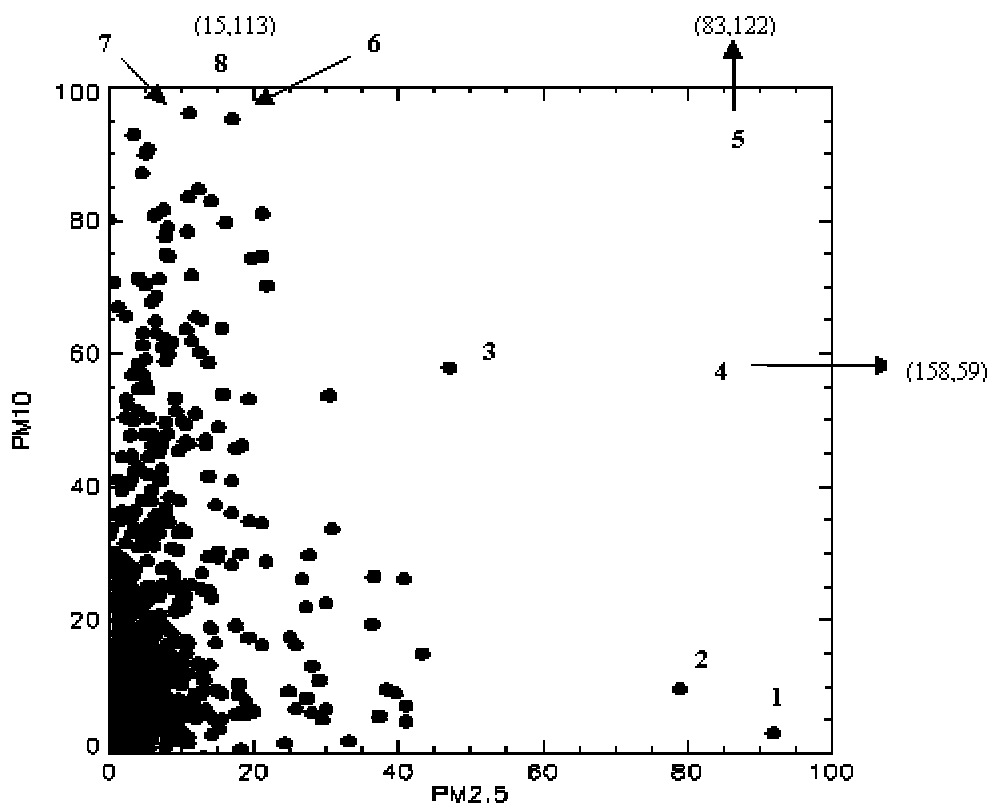

Figure 8. PMcoarse as a function of PMfine (values are in $\mu\text{g}/\text{m}^3$) at Miklatorg for the period Jan 1st 1995 to Feb 4th 2002. The filters selected for analysing are marked with

numbers. Number 4, 5 and 8 are outside the scale given in the figure and are marked with their real coordinate.

Secondly a selection of filters that have exceeded the allowed limit were chosen in combination with typical summer sample, not exceptionally high. In several cases two measurements in a row were taken to see if a pattern can be identified on a day to day basis. In Appendix I a summary of all measurements in the years 1999 -2002 is illustrated.

Meteorological conditions on the days selected was collected from the data base of the Icelandic Meteorological Office (IMO). The particle sampling site is located approximately one kilometre away from the IMO weather measuring station.

Information on asphalt work and reparations of streets in the near area was checked. This was to verify that repair work was not performed on the days selected for analysing. Emissions from such work is likely to affect the samples as well as road construction has an indirect effect by influencing the traffic flow.

Selection of source materials

The source material taken are asphalt, car exhaust, soil material, street salt and brake lining. It was emphasized to find a representative samples for airborne particulate material in Reykjavik. The preparation of samples is done in two steps. First representative samples of source material were collected in the field. There after samples of PM10 material were collected. In the latter step the same sampling device was used as for the ambient samples.

Sampling device for source materials

To collect PMcoarse and PMfine samples of source material a sampling device was developed in order to imitate the sampling method used for air pollution monitoring at Miklatorg, see figure 9. At EFA a spare equipment was available for the experiment. It consists of a *Sierra Andersen Dichotomous virtual impactor with 10 μ InletTM* and a pump. The samples are collected on Teflon filters. The *Sierra Andersen device* was placed in a tube for protection (83x20 cm) and then in a bigger tube, 200x31 cm. A support was fitted at 15 cm from the bottom of the outer tube in order to support the equipment. A hole was placed at 53 cm from the bottom and a sample container fitted into the hole and compressed air inlet was set into the container.

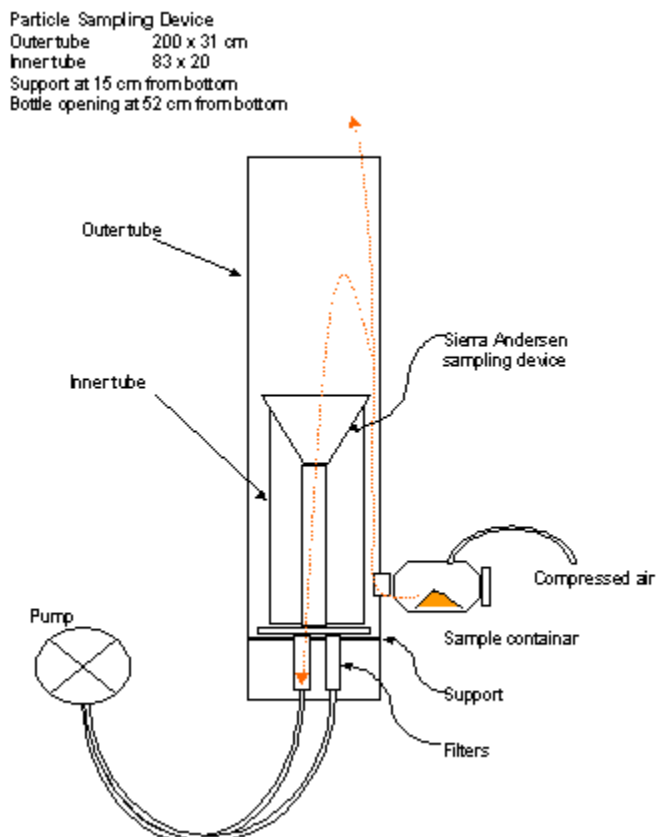

Figure 9. Particle sampling device used for collection of source material. The dotted line shows how the sample is blown through the outer tube and partly pumped through the filters.

Samples of soil and brake lining were blown in through the sample container, see figure 10. As for the exhaust gases a pipe was connected to the exhaust pipe and a container set in between the car and the sampling device in order to reduce water content of the exhaust gas, see figure 10. As for asphalt the outer container was not used but samples were collected directly into the inner tube.



Figure 10. Collection of source samples. Diesel and gasoline collection is shown to the right and soil, brake lining and salt to the left.

Asphalt

There are several different types of asphalt used in Reykjavik. The gravel is mainly of three origins. First *Seljalandsefni*, an Icelandic, strong material used on streets with heavy traffic. Secondly *Stavanger*, Norwegian material, strong and with light colour. It is preferred for its colour, to improve safety on the streets. Thirdly *Björgun*, Icelandic sea sediment, softer and used for streets with less traffic. In addition sand from Nupur in Ölfus, Iceland, is used in some amount.

At the Miklabraut/Bustadavegur intersection a special blend is used, with higher portion of strong material than normally. This material blend has been used since 1998 at this intersection. As the asphalt is an important factor in this study it was thought to be of utmost relevance to have a good representative sample. Therefore samples of asphalt were taken directly from Miklabraut, right by the monitoring station. Four cores were drilled out from the street. The cores were then taken to an equipment used for measuring resistance of asphalt to studded tyres (Tröger Instruments), see figure 11. It consists of steel threads, that hammer onto the asphalt cores, simulating the wearing of asphalt by studded tyres. During the hammering asphalt dust is formed and PM was collected with the the *Sierra Andersen device*.



Figure 11. Equipment for measuring resistance of asphalt to studded tyres (Tröger Instruments) used in this study to collect asphalt PM.

Soil erosion

Samples of soil material were selected in cooperation with the Agricultural Research Institute [8]. Three types of soil were taken to be representative for airborne materials in the Reykjavik area, taken into account that dominant wind direction in Reykjavik is east, see figure 12 for orientation of the sites.

- Soil from Reykjavik outskirts are taken at Korpa, see figure, close to the surface, high in organic material, highly weathered.
- Samples taken at the same site, Korpa, but deeper from surface, rich in organic material and not weathered.
- Long range transported material taken from Mosfell, an open mine 20 km NA from Reykjavik, see figure. The soil is a river sediment, low in organic material, highly weathered with fine particles.

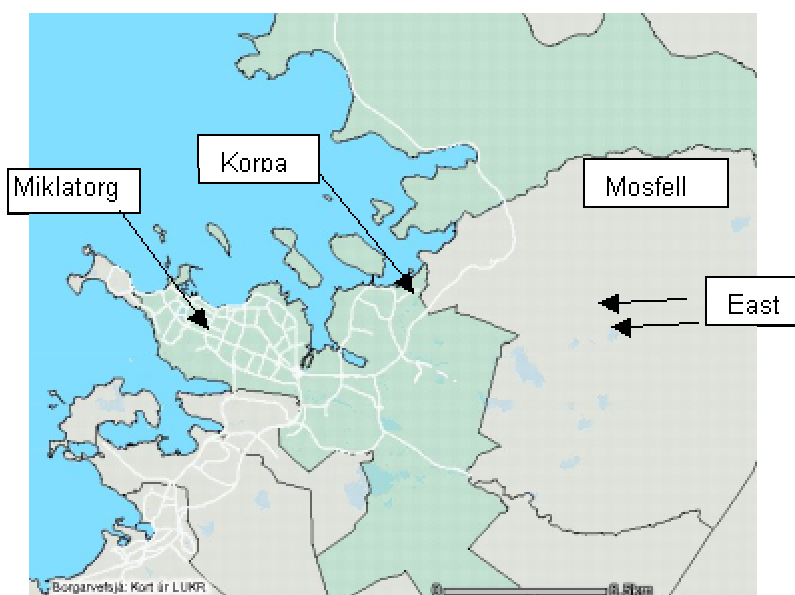

Figure 12. Soil samples were collected East of Reykjavik, both long range and short range transported matter.

Car exhaust soot

Samples were taken from two types of cars, diesel and gasoline, Mitsubishi L300 1991 using 95 octane gasoline and a diesel car, Landrover Discovery 1997.

Brake lining

A garage which specializes in brakes, called Hemill, provided brake lining dust to the project. The dust is a sample from the ventilation system in the garage which collects all dust and abrasion deriving from the main work station. The sample is not pure brake lining as metallic parts of brake systems (brake discs and brake drums respectively) will wear down along with the brake lining. Other impurities are not expected. The majority of the dust is collected in a bag but the finest particles are filtered out. The samples used are taken from filters, at the garage, that collect the fine dust.

Salt

Samples of street salt were collected from Reykjavik city road department for NIRS analysis. No ICP measurements were performed for salt but the known combination of sea salt was substituted for ICP results [9].

Results

The total amount of samples analysed was 124 samples; PM_{fine} and PM_{coarse} samples for 26 selected days and 36 samples of source materials. The results are reported for samples from 16 days and in two cases only for coarse or fine matter, see table 4. The reason for the absence of results for 10 days is that the NIRS analysis was not successful for unknown reason. The failure was not discovered until after the samples had been dissolved for the ICP analysis and it was therefore not possible to repeat the analysis. One sample did not fit into the model and was taken out during the statistical analysis. This was the 31. of December where the chemical composition of PM is in no way comparable to other days. The reason is believed to be that at this particular night firework smoke fills the air in Reykjavik and no notice was taken for this particular source of particulate matter in this study.

Table 4. The dates and amount of PM for the monitoring samples.

	Sample	Year	Month	Day	PM _{fine} µg/m ³	PM _{coarse} µg/m ³	Total PM µg/m ³	PM10 / PM2,5
*	3054	1999	1	26	83	122	204	0,7
*	3069	1999	3	4	11	96	107	0,1
	3294	2000	6	18	4	15	19	0,3
	3307	2000	7	18	3	20	23	0,1
*	3371	2000	11	23	5	87	92	0,1
*	3388	2000	12	27	41	102	144	0,4
	3392	2001	1	4	6	42	47	0,1
*	3409	2001	2	5	3	53	56	0,0
*	3578	2002	1	21	6	91	96	0,1
	3580	2002	1	25	7	33	40	0,2
*	3581	2002	1	27	8	79	87	0,1
*	3593	2002	2	26	9	74	83	0,1
	3594	2002	2	28	6	37	42	0,2
*	3602	2002	3	16	17	33	50	0,5
*	3603	2002	3	18	8	100	107	0,1
*	3604	2002	3	20	4	51	55	0,1
* Total PM is over the 50 µg/m ³ limit								

Weather

Weather information for the selected days is given in table 5. Sampling time is 24 hours from 09:00 – 09:00 in the morning. Temperature, wind speed and atmospheric pressure are given as an average for the 24 hours of sampling and precipitation is reported for the sampling time. Snow cover is reported as an average for 2 days, that is 48 hours. Information on salting of streets is added to table 5. For salting the symbols used are; two rounds of salting or more: ++ ; one round of salting: + ; no salting: -
A more detailed weather description is given in Appendix II.

Table 5. Weather information for the days reported.

Sample	Year	Month	Day	Temp °C	windspeed m/s	Pressure hPa	downfall mm	rain 0/1	sleet 0/1	snow 0/1	snowcover lowland mm	snowcover mountain mm	Wind direction	Salting of streets
3054	1999	1	26	-0,6	9,0	996,1	8,8	0	1	0	4	4	E	++
3069	1999	3	4	-4,4	3,4	1023,5	0	0	0	0	4	4	NW-E	-
3294	2000	6	18	9,4	1,9	1001,3	11,9	1	0	0	0	0	2 EN-W-E	-
3307	2000	7	18	10,4	7,5	1000,4	0	0	0	0	0	0	0 SW	-
3371	2000	11	23	-0,8	1,3	998,8	0	0	0	0	0	0	1 SSE	+
3388	2000	12	27	-8,2	1,3	1015,6	0	0	0	0	0	0	4 ENE	-
3392	2001	1	4	-6,8	1,0	1001,6	0	0	0	0	2	2	2 SE-N	-
3409	2001	2	5	-2,6	2,9	1001,6	0	0	0	0	2	2	4 SE-NE	+
3578	2002	1	21	0,4	4,2	997,0	0	0	0	0	0	0	2 ENE-SE	-
3580	2002	1	25	-5,0	5,7	997,3	0	0	0	0	0	0	2 ENE-SE	-
3581	2002	1	27	-7,6	2,9	998,1	0	0	0	0	0	0	2 ENE-SE	-
3593	2002	2	26	-7,4	2,9	1002,8	0	0	0	0	2	2	4 ENE-SE	-
3594	2002	2	28	-0,7	2,5	1019,8	1,3	0	0	1	4	4	4 ENE-N	-
3602	2002	3	16	1,9	3,4	1008,1	0	0	0	0	0	0	4 E	+
3603	2002	3	18	-4,3	2,8	1013,4	0	0	0	0	0	0	4 ESE	-
3604	2002	3	20	0,0	5,3	1013,6	0	0	0	0	0	0	3 ENE	+

Analytical results

The results for the ICP-OES and ICP-MS analysis is shown in Appendix III. For all measured components the source samples give comparable or higher results than the ambient air pollution samples, except for Mn and Co that is higher for some days than in the source samples. At first glance this indicates that there is a source of particulate matter that is not covered by the samples tested, but when taken a closer look, one can see that these peaks are only seen in the oldest samples. Therefore it is possible that some contamination has occurred during sampling or handling of the filters. In any event these analytes were excluded from the modelling work. Some analytes had maximum concentrations only marginally higher than the corresponding detection limit. Such analytes are bound to contribute mainly noise to the model as they were consequently excluded. These were B, K, S, As, Cd, Cr and Hg. Nb and Zr gave acceptable analytical results, but these elements had very little influence on the first four principal components, indicating that these variables are unimportant in explaining the variability amongst the source samples. Nb and Zr were thus excluded from the modelling work.

Multivariate modelling

In Appendix IV the results from the statistical calculations and multivariate modelling are given. Some adjustments were needed for this data. In some instances the model gave negative results which can be regarded as noise. It was therefore decided to delete all figures plus/minus 0,05 or in other words all concentrations in the model below 5%, see appendix IV. Further more it was decided to delete brake lining before presenting the results. Brake lining is detected in high percentage in certain samples in the modelling. Comparison to the ICP analysis data revealed that this could not be the case as the most important elements in the brake lining analysis were not giving peaks in these samples. Brake lining did not fit well into the model, perhaps because it is a minor source. All together brake lining did not give high scores and it is obviously not more than 2-3 % of

the PM10 in total. In order to clarify the results they are presented without the brake lining below.

In the beginning, three different soils, marked a, b and c, were included. Soil samples a and b, a topsoil and a less weathered deeper horizon respectively, are taken from the same spot within the city limits. They both contain much fine grained brown material high in organic content. These samples were expected to be typical for air-borne soil materials in Reykjavik. Soil c is a "dug-up" grey river sediment from an area outside Reykjavik. This was taken along as a supplement in a gesture to model less organic materials originated from eroded areas further inland. It turned out that a and b were unseparable by the model and that they actually behaved more or less like one sample. They were consequently modelled as a single source, soil a+b. Soil c proved to overlap seriously with the asphalt. Thus asphalt was modelled as soil c and vice versa so soil c had to be left out from the modelling work. One can assume that this soil type is not a major source of air-borne materials in Reykjavik since the model returned total values quite close to 100% with the set of 5 sources used in the final modelling work.

In the first tests rounds of the modelling gasoline and diesel exhausts were treated as different sources. The two showed marked overlap and were consequently treated as one parameter called soot.

Several gaps are in the modelling results shown in Appendix IV. These figures have been marked as outliers in the model meaning that the source is not determined with sufficient confidence (95 % level). In few cases, whole samples are deleted manually. These were summer samples and regarded as not fitting into the model possibly due to some other sources, not included in this work.

Altogether it can be said that the model is giving convincing results for the ambient air pollution samples presented here, based on two facts. The model recognises the sources with the requested confidence and secondly the outcome is generally giving total amount in samples close to 100%.

Predicted composition of PM in ambient air pollution

The results for the predicted composition of particulate matter in Reykjavik are presented here below for PMfine (fine material) and PMcoarse (coarse material) separately, as these are collected on separate filters and therefore analysed separately. In figure 13 and 14 the percentage of each source material is shown for the 16 days reported here, plus the average for these days.

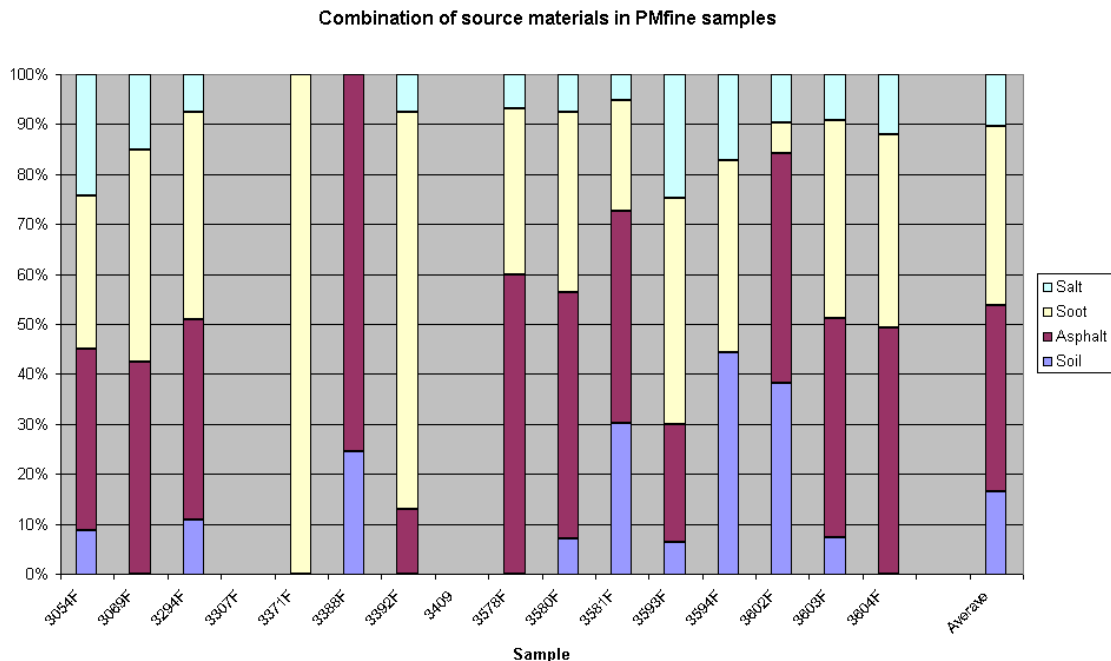

Figure 13. Percentage of each source material in PMfine samples.

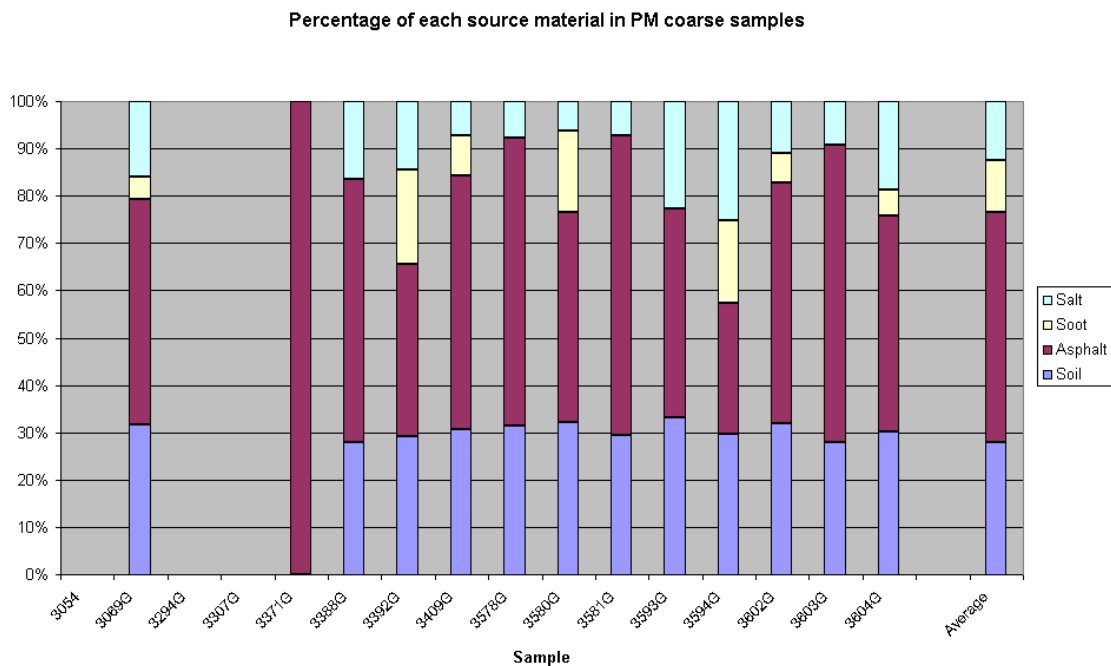

Figure 14. Percentage of each source material in PMcoarse samples

In figure 15 and 16 the combination of source materials is given in $\mu\text{g PM}/\text{m}^3$ air. The bigger samples and the most problematic days can be better examined in these figures.

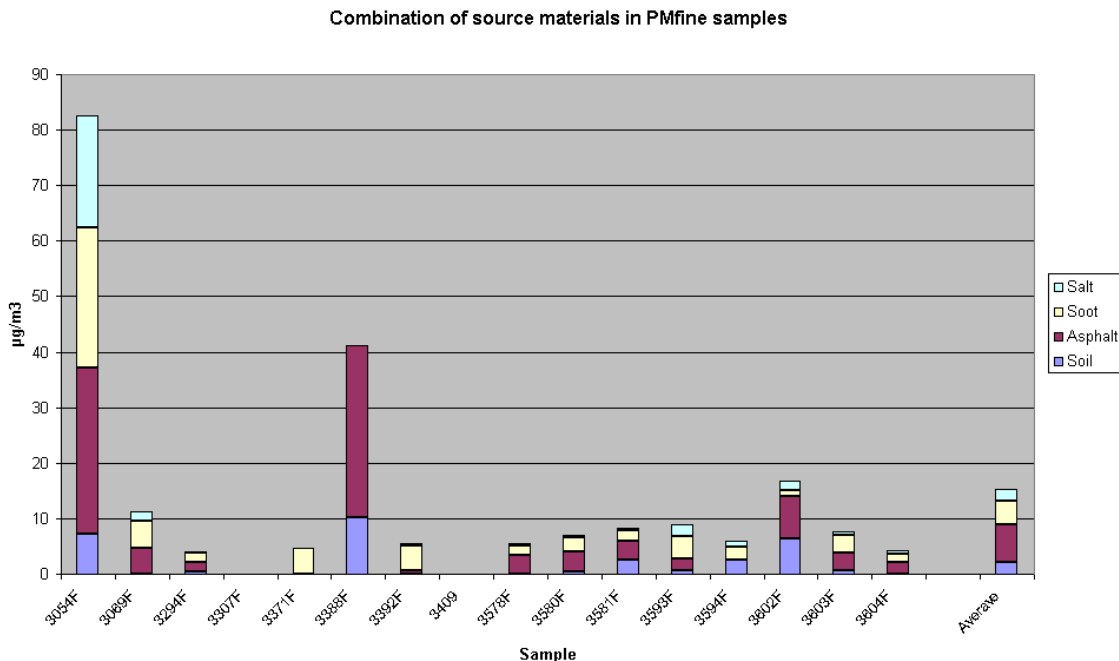

Figure 15. Combination of source materials in PMfine samples in $\mu\text{g}/\text{m}^3$.

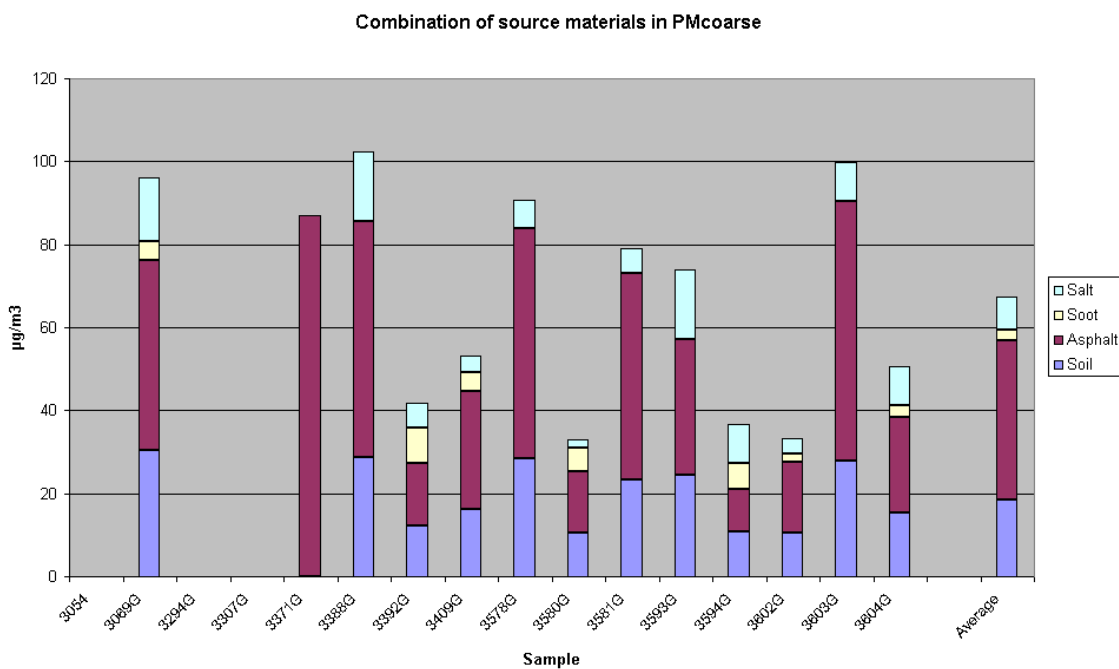

Figure 16. Combination of source materials in PMcoarse samples in $\mu\text{g}/\text{m}^3$.

In figure 17 the fine and coarse material have been added together giving composition for total PM10, here shown in actual concentrations.

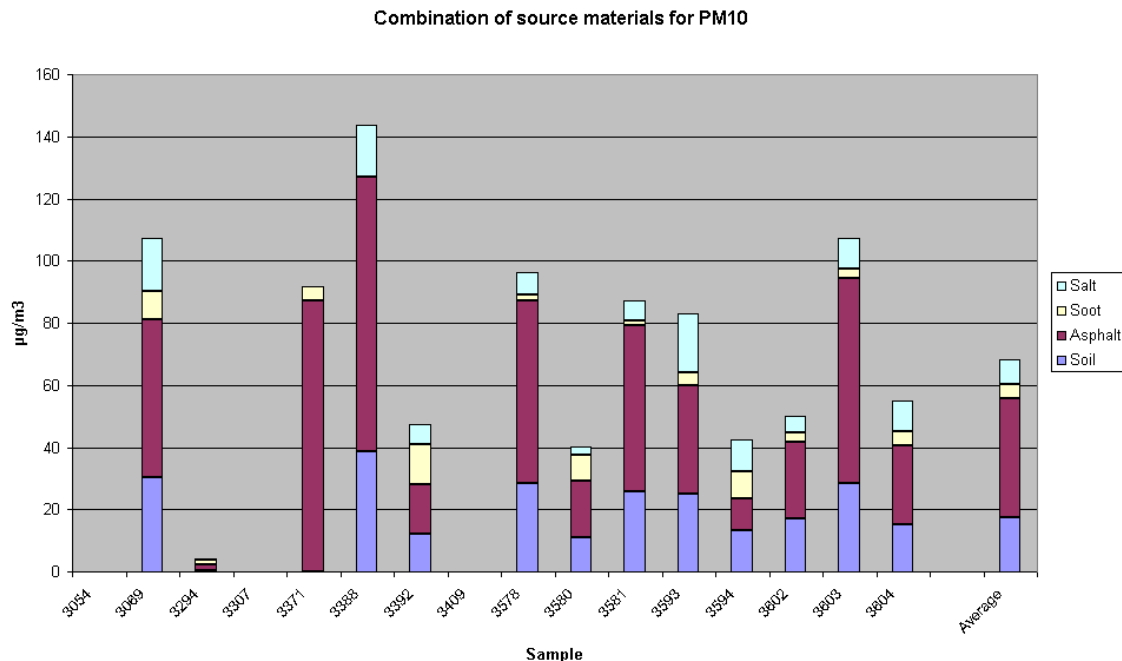

Figure 17. Combination of source materials for total PM10.

An average combination of the particulate matter for the days reported is shown in figure 18. In this picture brake lining is estimated to be around 2% of the total amount, as stated earlier. Other figures are based on the results presented in figure 17. Brake lining was detected in some samples even though it was taken out of the model at later stages.

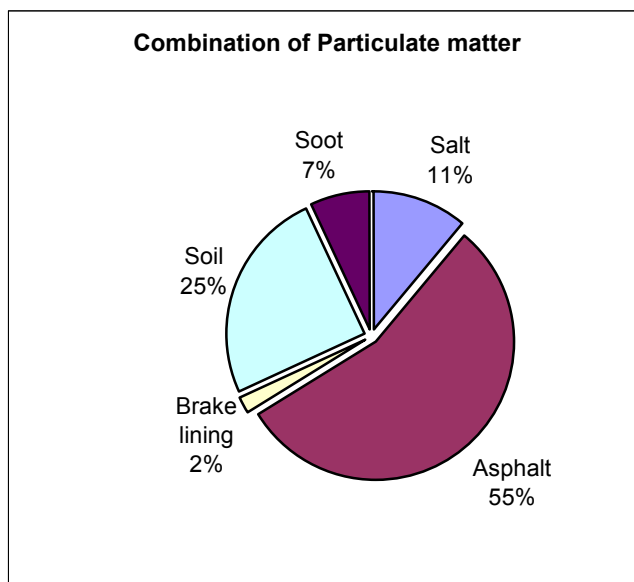

Figure 18. Average combination of source materials in PM10 for the measured winter days.

Figure 19 illustrates the combination of PM10 for the most problematic days, that is samples with PM10 around or above $50 \mu\text{g}/\text{m}^3$, which is the limit value set in regulations. The composition on these days is on average 26% soil, 59 % asphalt, 4% soot and 11% salt.

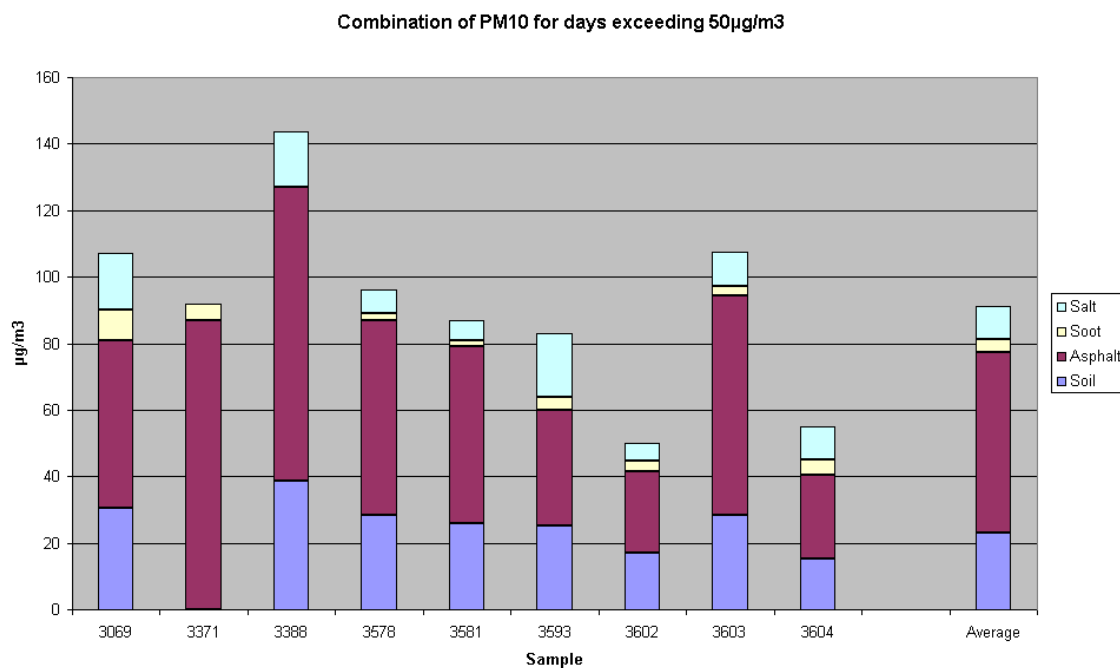

Figure 19. The combination of source materials on the most problematic days, given for total PM10.

In figures 20 and 21 the ambient air samples are divided in two groups, wet days and dry days. All days with precipitation and snow covering the ground are in the group wet days. It should be noted that the street may be free of snow cover and/or dry even though snow is covering the ground as salting and traffic melts the snow and facilitates the drying of the streets

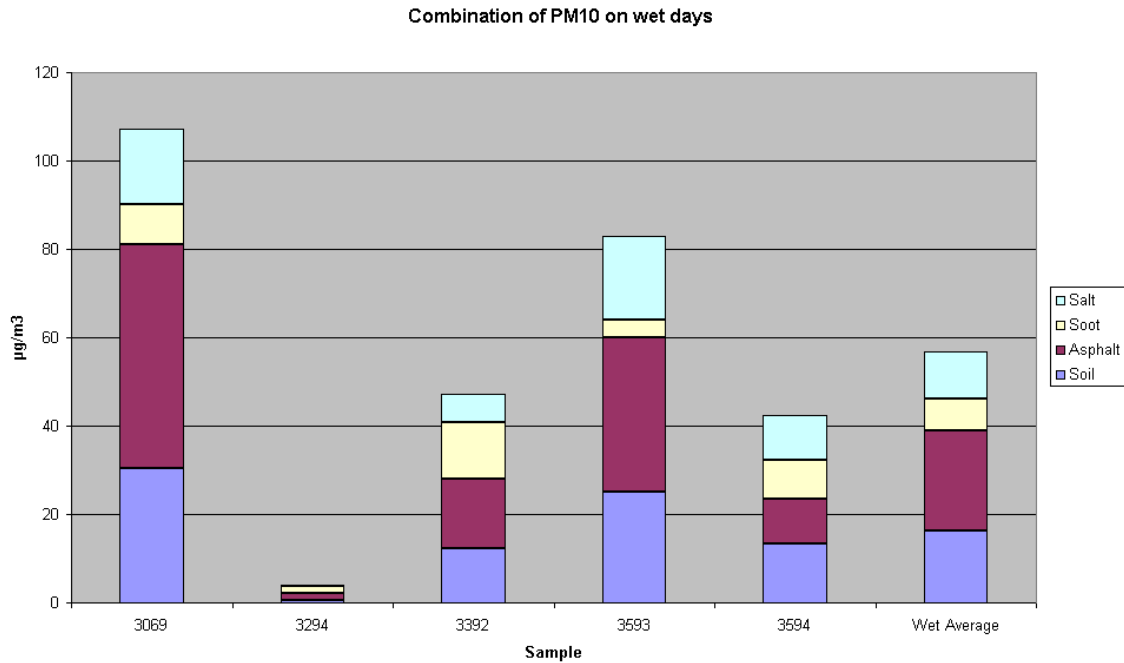

Figure 20. Combination of source materials for PM10, on days defined as wet.

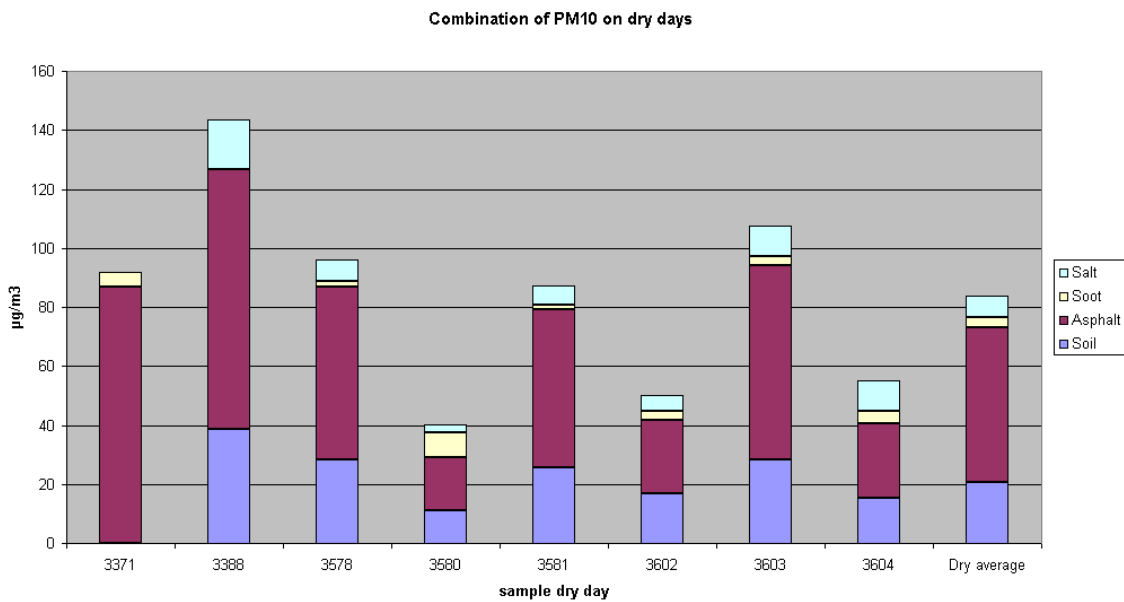

Figure 21. Combination of source materials for PM10, on days defined as dry.

Discussion

The objective of the project was to develop a method or measuring process to determine the origin of airborne particulate matter. This was done successfully and the proposed methodology gives usable results for interpretation. Several simplifications needed to be done during the modelling and it is therefore of importance to carefully interpret the results. Still, the model is showing results reflecting the overall situation.

The modelling does though give room for improvements. Some samples did not fit into the model, such as the summer samples. This indicates that there might be a source for PM in summertime that is not detectable by the sources used in this modelling. It is suggested here that pollen and spores might be a source not taken into account in the modelling at hand. Spores do have diameter less than 10 μm and some pollens as well. This and other materials of biological origin might besides go through a process of grinding on the road surface.

Looking at the weather conditions for the problematic days it is generally cold and fairly calm wind with dominating north and east wind. On most of the days examined there is little or no precipitation and the ground is often covered by snow. Although snow is reported in the weather data the streets might be without snow cover and even be dry on these days, as the salt and traffic clears the surface. One might expect that under these condition PM is fairly high. Dust might accumulate on the wet and snowy streets and as the streets become dry the particulate matter is resuspended in air. Two summer samples are included for reference even though the total PM₁₀ for those days is far below the limit value set in regulations.

The result from the model show that the average combination of particulate matter in Reykjavik during winter time is such that asphalt is contributing the greatest share of the particulate matter. Asphalt is around 55%, while soil contributes only half of that, 25%, and soot even less or 7%, salt is on average 11% and brake lining around 2%

As a comparison Thordarson reported the PM₁₀ to constitute of 30% soil, 15% exhaust and 55% asphalt. These findings are in good agreement with the above results, especially as these results can be seen as yearly averages. As Thordarson uses a different approach to the research question, the similarity of the results adds confidence to the main findings.

The results can also be compared to the situation in Norway. In Norway there are several sources for particulate matter as in Iceland, though they are not the same. Wood burning, industry and long ranging pollution do contribute to PM pollution in Norway, while soil and salt are not suspected sources. In Norway both road traffic and wood burning (for house heating) are important, and the dominating contributor of the two depends on actual location. [10] Wood burning is typically dominating in the central downtown area while road traffic is of most importance along the main road system. In central Oslo it is estimated that while wood burning is 63 % of the daily PM₁₀ while road traffic is 30 % for yearly averages. For the days with the highest concentrations, that is the most problematic winter days, asphalt is estimated to be around 90% of the total PM₁₀ while

on average it is around 25 - 50%, with the highest concentrations close to roads [11]. Compared to the results given in this study, traffic seems to be even more dominating on the most problematic days in Oslo than in Reykjavik.

The overall pattern seen in our results for coarse particles on one hand and fine on the other hand is somewhat different. The combination of sources for coarse particles is stable from one day to another while the combination for fine particles is much more varying. Soil and asphalt is seen in higher concentrations in coarse fraction while soot is detected in higher concentrations in the fine fraction. The high concentrations of soot particles in PM_{fine} is not reflected in the results for total PM as the mass of the fine material is much less than for the coarse material, that is the fine particles are weighing less in the total result. Still it is noteworthy that soot is seen in such high concentrations in the PM_{fine}.

Salt is seen in most samples in even portions in fine and coarse material respectively, and no obvious correlation is seen between salting of streets and salt in ambient air samples. Sea salt is therefore still a suspected source.

A comparison between wet and dry days indicates that asphalt is strongly dominating dry days while soot and salt are seen in fairly high concentrations of wet days. It must be noted that this comparison is done for only few days but the difference is quite definite.

Looking at the most problematic days, or those days that exceed the limit value set in regulations, asphalt is an even larger part of the total PM₁₀ than on average in winter time or approximately 60%. This puts the focus even stronger on studded tyres in the wintertime, when the most problematic days arise. In Iceland 60% of the winter traffic uses studded tyres [12]. It has been shown that other types of winter tyres, e.g. new types of hard grain tyres, wear the asphalt only 7% compared to traditional studded tyres. Based on this and the result at hand one can assume that reduction in use of studded tyres might affect the concentration of particulate matter dramatically.

In Oslo this approach has already been taken and from 1992 - 2001 the use of studded tyres was reduced from 81 to 21 %. On average for the period the reduction in PM₁₀ concentration is 1 µg/m³ (24hours value, wintertime) with every 10% of studded tyres taken from the roads. The trend is not seen in town called Drammen where reduction of studded tyres was only 5% in the same period. [13]

The results of this study suggest that traffic related sources, that is asphalt and soot, are responsible for over 60% of the ambient air particulate pollution in winter time. A dramatic action to reduce the PM pollution would be to reduce traffic in the city. There are number of actions that can be taken, such as to encourage the use of public transport.

The project is a cooperation between IceTec in Reykjavik, Environment and Food Agency of Iceland and NILU in Oslo. IceTec was project leader. A steering group was formed with representatives from IceTec, NILU, EFA, City of Reykjavik - Office for the Environment and Public Roads Administration.

The project was financially supported by NordTest, Icelandic Public Roads Administration and City of Reykjavik - Office for the Environment.

Thanks to:

Magnús Valdimarsson, IceTec for assistance with sampling and analysis. Malbikunarstöðin Höfði for providing samples of asphalt from Miklabraut. Hemill Garage for collecting brake lining material. The Building Research Institute, Arnþór Óli Arason and Þórir Yngason, for assistance with the asphalt PM collection. Icelandic Meteorological Office, Guðrún Gísladóttir for assistance with weather data. Tore Skjenstad, Hafnarfjörður and Kópavogur OE, Steingrímur Benediktsson, Kemia for providing equipment. Steering group and Halla Jónsdóttir, IceTec for various assistance and proof reading.

References

- [1] Thordarson, Ylfa.; Magn og uppspretta svifryks – Rannsókn á loftmengun í Reykjavík, Linuhonnun consulting, Reykjavík, october 2000
- [2] Jörundardóttir, Hrönn Ólína; Þróun aðferðar til greiningar og frumefnagreiningar á fjölhringja kolvatnsefnum í andrúmslofti á Íslandi, University of Iceland, ref. Kristín Olafsdóttir, 2001
- [3] City of Reykjavík - Office for the Environment, Mengunarfar í amdrúmslofti í Reykjavík, reports from 1990-1999.
- [4] Environment and Protection Agency of Iceland, www.ust.is
- [5] Skuladóttir, B., Thordarson, H., Environmental evaluation for the ECTOS project - Mid-term report. Unpublished.
- [6] Björg Helgadóttir, Environmental and Technical Sector of the City of Reykjavík (Umferðardeild Borgarverkfræðings), personal communication.
- [7] Icelandic Meteorological Office, www.vedur.is
- [8] Dr. Ólafur Arnalds, Agricultural Research Institute, Personal communication.
- [9] Handbook of Chemistry and Physics, 67th ed., CRC Press, 1985-1986.
- [10] Laupsa, H. and Slørdal, Applying model calculations to estimate urban air quality with respect to the requirements of the EU directives on NO₂, PM₁₀ and C₆H₆. Internat. conf. on harmonisation within atmospheric dispersion modelling for regulatory purposes (8 : 2002 : Sofia). Proceedings. Sofia, Demetra Ltd., 2002. pp.429-433.
- [11] Larssen, S., Hagen, L.O. Luftkvalitet i norske byer, NILU OR69/98, December 1998.
- [12] Thorir Ingason, Asbjörn Johannesson,; Studded tires, status evaluation; BUSL - cooperation in the field of road research in Iceland. Report number: S-23, Icelandic Public Roads Administration 2002.
- [13] Bartonova, A., Larssen, S. og Hagen, L.O., Utvikling i luftforurensningen 1991-2001. Utslippsreducerende tiltak og PM₁₀ partikkelkonsentrasjoner i Oslo og Drammen., OR 10/2002, NILU 2002

List of abbreviations

PM	Particulate matter
PM10	Particulate matter with diameter < 10 μm
PMcoarse	Particulate matter with diameter 2,5 - 10 μm
PMfine	Particulate matter < 2,5 μm
IceTec	Technological Institute of Iceland (Iðntæknistofnun)
EFA	Environment and Food Agency of Iceland (Umhverfisstofnun)
NILU	Norwegian Institute for Air Research (Norsk Institutt for Luftforskning)
ROE	City of Reykjavik - Office for the Environment (Umhverfis- og heilbrigðisstofa Reykjavíkurborgar)
IMO	Icelandic Meteorological Office (Veðurstofa Íslands)
NO _x	Nitrogen oxides
THC	Total hydrocarbon
PAH	Poly-aromatic hydrocarbons
NIRS	Near Infrared Reflectance Spectroscopy
ICP	Inductively Coupled Plasma spectroscopy
ICP-MS	Inductively Coupled Plasma - Mass Spectrometry
MLR	Multiple linear regression
PCR	Principal component regression
PLS	Partial least squares regression

Annex I - PM10 concentrations Miklatorg January 1999 - July 2002

The figures are based on data from EFA. Note that the scale is different, due to severe difference in maximum values each year.

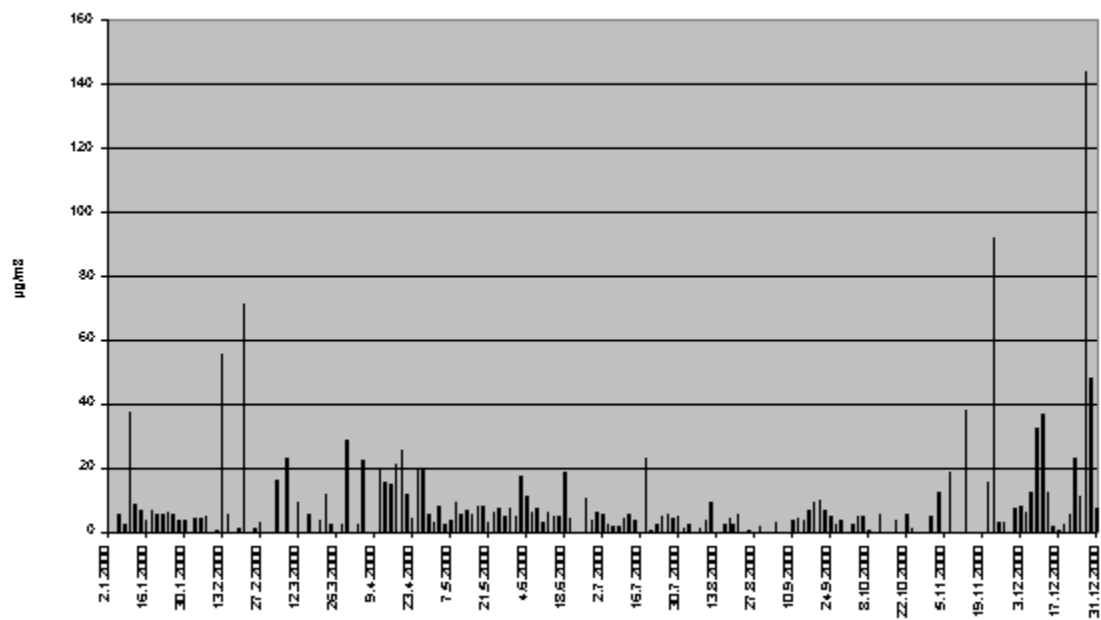
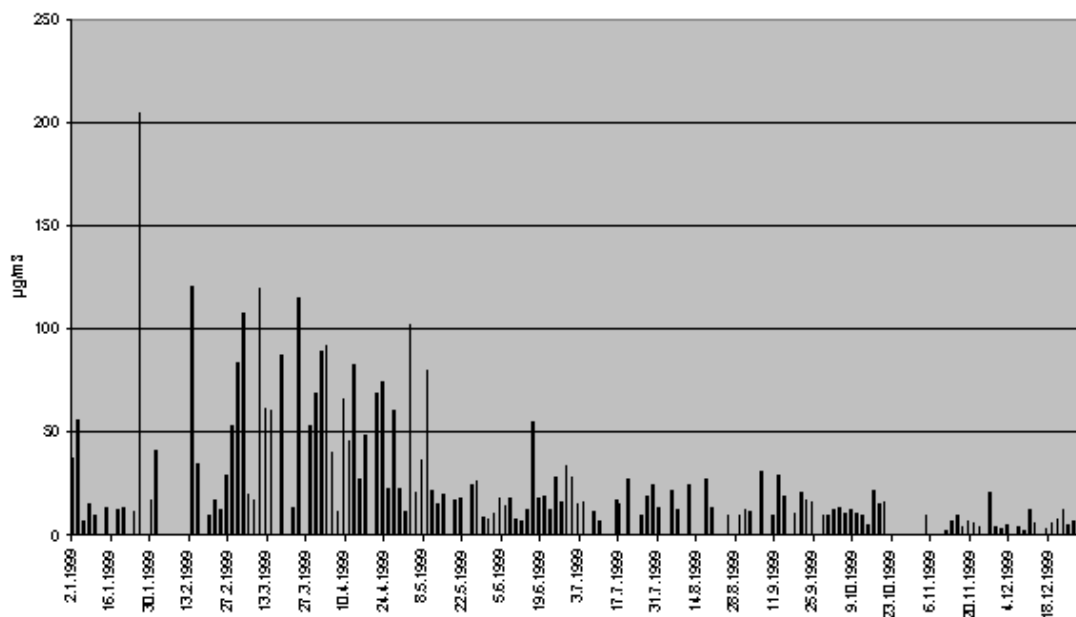

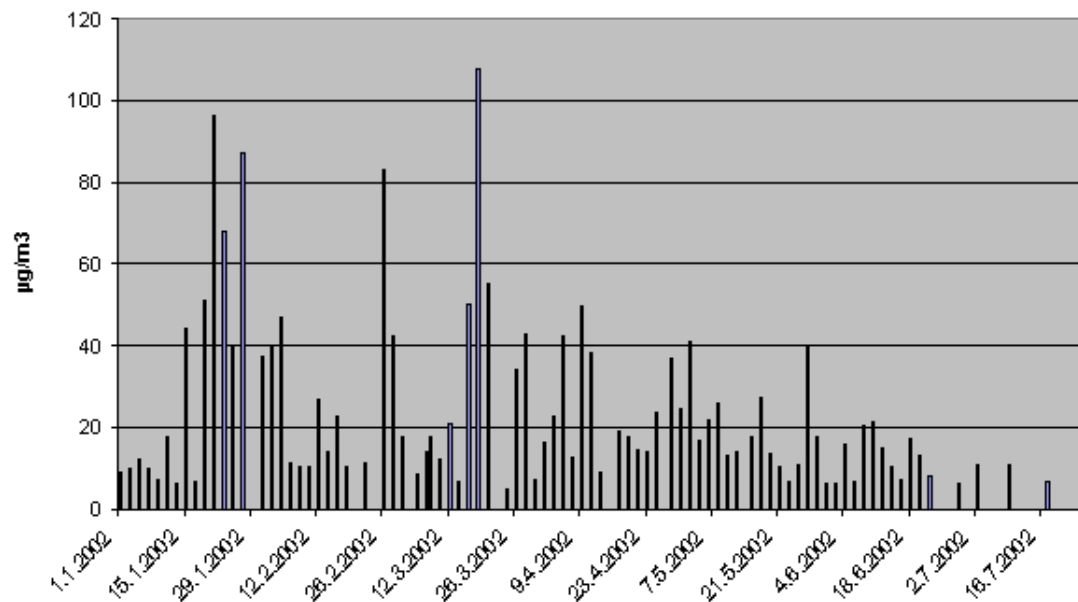
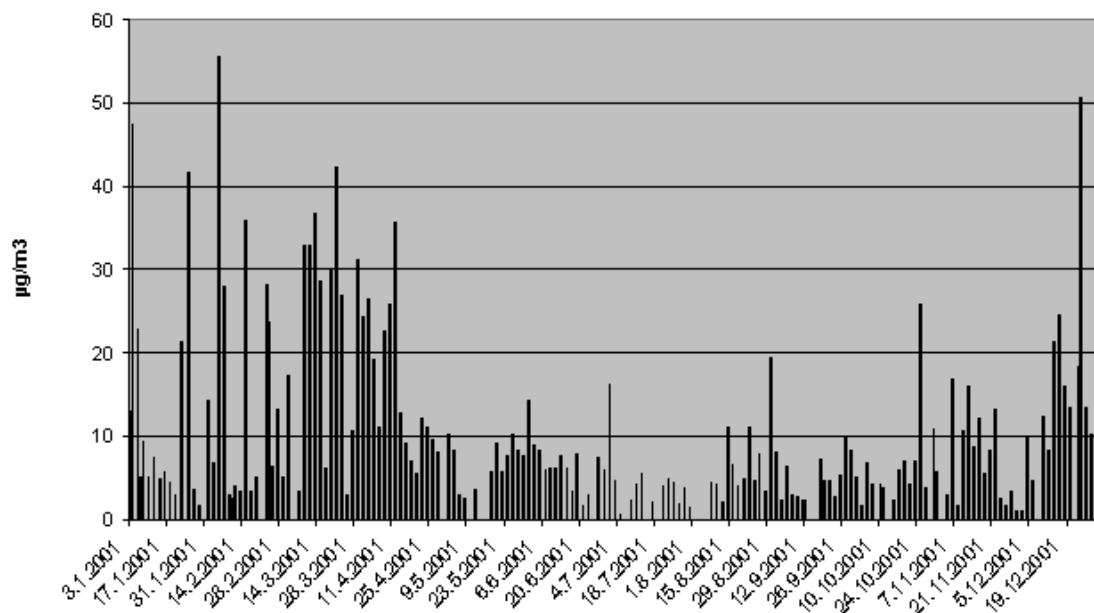

Annex II - Weather data for the selected days

t	Temperature
td	Dew point
d	Wind direction
f	10 min windspeed
n	Clouds
v	Visibility
p	Pressure hPa
nh	Cloud cover lowest clouds
h	Height lowest clouds
sncm	Snow cover mountains
r	Precipitation 24 hours (from 09 to 09)
rn	Rain (marked 1 or 0)
sl	Sleed (marked 1 or 0)
sn	Snow (marked 1 or 0)
snc	Snow cover lowland

1999																			
3054	year	month	day	hour	t	td	d	f	n	v	p	nh	h	snc	sncmr	rn	sl	sn	
1999	1	26	3	-0,6	-6,7	110	3,6	4	86	1002,8	2	7	4	4		0	0	0	
1999	1	26	6	-1,3	-8,1	90	5,1	0	86	1003,5		9							
1999	1	26	9	-2,9	-4,2	80	4,1	1	89	1004,9	1	6							
1999	1	26	12	-2,4	-7,2	90	3,6	3	89	1005,1	1	6							
1999	1	26	15	-1,2	-6,0	80	5,1	7	89	1003,6	2	6							
1999	1	26	18	-1,8	-3,3	100	10,8	8	25	1001,1	8	2							
1999	1	26	21	0,3	-1,4	110	10,3	8	30	999,3	8	2							
1999	1	26	24	-0,6	-2,2	100	9,8	8	59	996,5	8	2							
1999	1	27	3	0,0	-0,6	100	11,8	9	8	990,6	/		4	4	8,8	0	1	0	
1999	1	27	6	0,4	-0,7	90	12,4	9	8	986,5	/								
1999	1	27	9	0,8	-0,9	100	8,2	8	20	986,1	6	3							
1999	1	27	12	1,9	0,3	100	3,1	7	70	986,7	4	4							
1999	1	27	15	1,8	0,4	80	4,1	6	84	986,6	4	5							
1999	1	27	18	2,1	-0,4	80	4,6	6	84	987,5	4	5							
1999	1	27	21	1,8	-1,6	80	4,1	3	84	990,0	1	5							
1999	1	27	24	1,6	-1,9	100	3,6	6	84	992,2	5	5							
average 09 - 09					-0,6	-2,8	96,3	9,0	7,5	41,0	996,1	5,5	3,5	4	4	8,8	0	1	0
3069	year	month	day	hour	t	td	d	f	n	v	p	nh	h	snc	sncmr	rn	sl	sn	
1999	3	4	3	-3,9	-10,3	350	4,6	1	86	1020,8	1	5	4	4		0	0	0	
1999	3	4	6	-3,5	-7,5	10	2,6	1	89	1021,1	1	5							
1999	3	4	9	-3,8	-8,8	30	4,1	1	89	1022,0	1	5							
1999	3	4	12	-1,5	-9,8	10	3,1	1	89	1022,6	1	5							
1999	3	4	15	-1,8	-10,8	20	6,7	3	89	1022,7	0	9							
1999	3	4	18	-2,8	-10,0	250	2,6	6	89	1023,6	0	9							
1999	3	4	21	-4,2	-10,7	90	3,1	1	89	1024,3	0	9							
1999	3	4	24	-3,9	-6,9	240	2,1	1	89	1024,2	0	9							
1999	3	5	3	-7,0	-13,4	110	3,6	1	89	1023,9	0	9	4	4		0	0	0	
1999	3	5	6	-7,0	-12,3	100	2,6	1	89	1023,1	0	9							
1999	3	5	9	-6,8	-12,6	100	3,6	6	89	1023,6	6	9							
1999	3	5	12	-3,6	-9,8	90	2,6	8	70	1022,9	4	6							
1999	3	5	15	-0,4	-6,8	210	2,1	8	84	1021,6	1	6							
1999	3	5	18	-1,4	-5,5	100	3,1	8	56	1020,4	5	3							
1999	3	5	21	-1,9	-3,1	70	4,6	8	56	1018,1	5	3							
1999	3	5	24	-1,8	-3,3	90	3,1	8	56	1018,5	8	3							
average 09 - 09					-4,4	-10,8	115,0	3,4	2,5	89,0	1023,5	0,9	8,5	4	4	0	0	0	0
2000																			
3294	year	month	day	hour	t	td	d	f	n	v	p	nh	h	snc	sncmr	rn	sl	sn	
2000	6	18	3	8,7	7,0	90	2,6	8	81	1004,2	6	5	0	2	6,6	1	0	0	
2000	6	18	6	8,7	7,4	80	2,6	8	68	1003,0	6	6							
2000	6	18	9	8,7	7,2	70	2,1	8	57	1002,7	8	4							
2000	6	18	12	9,4	8,4	70	2,1	8	40	1001,5	8	3							
2000	6	18	15	9,6	7,9	350	3,1	7	68	1000,5	7	4							
2000	6	18	18	10,9	8,9	340	3,1	6	80	1000,3	4	4							
2000	6	18	21	11,1	7,4	330	1,5	6	82	1000,5	6	3							
2000	6	18	24	9,2	7,5	230	1,0	7	84	1000,9	7	4							
2000	6	19	3	8,3	7,4	130	1,5	7	80	1001,2	5	3	0	2	12	1	0	0	
2000	6	19	6	7,8	6,0	90	1,5	7	80	1002,4	7	4							
2000	6	19	9	8,7	5,6	10	1,5	7	84	1003,3	7	5							
2000	6	19	12	10,1	6,0	20	2,1	7	88	1004,1	7	5							
2000	6	19	15	12,8	4,8	10	3,6	5	84	1004,4	5	6							
2000	6	19	18	13,8	3,7	100	1,5	6	86	1005,0	6	5							
2000	6	19	21	12,6	6,3	130	2,1	6	89	1005,6	6	5							
2000	6	19	24	10,8	8,1	110	2,6	7	89	1006,7	7	5							
average 09 - 09					9,4	7,4	193,8	1,9	6,9	74,8	1001,3	6,4	3,8	0	2	12	1	0	0

2001																				
3392	year	month	day	hour	t	td	d	f	n	v	p	nh	h	snc	sncm	r	rn	sl	sn	
2001	1	4	3	-11,2	-17,2	150	1,0	0	89	1000,7	9	2	2				0	0	0	
2001	1	4	6	-10,5	-16,8	100	1,5	0	89	1000,6	9									
2001	1	4	9	-9,9	-15,9	120	2,6	1	89	1001,3	1	8								
2001	1	4	12	-8,6	-15,2	120	0,5	1	88	1001,5	1	5								
2001	1	4	15	-8,3	-14,8	140	1,0	1	88	1001,2	0	9								
2001	1	4	18	-8,5	-13,9	-	1,0	1	88	1001,3	0	9								
2001	1	4	21	-7,0	-13,4	40	2,1	2	88	1001,7	2	9								
2001	1	4	24	-5,8	-11,1	310	0,5	7	87	1002,1	7	7								
2001	1	5	3	-4,1	-7,9	50	1,0	7	89	1001,6	2	6	2	2			0	0	0	
2001	1	5	6	-5,8	-11,6	140	1,0	3	89	1001,3	3	7								
2001	1	5	9	-6,6	-11,8	150	0,5	3	89	1002,2	2	6								
2001	1	5	12	-6,8	-12,0	110	2,1	6	82	1002,8	2	6								
2001	1	5	15	-5,9	-12,3	140	1,5	6	84	1002,1	1	8								
2001	1	5	18	-7,3	-11,3	110	1,0	1	84	1002,1	1	7								
2001	1	5	21	-7,2	-9,3	140	1,0	1	84	1003,1	1	7								
2001	1	5	24	-9,6	-11,2	90	1,5	1	84	1003,1	1	4								
average 09 - 09																				
					-6,8	-12,5	135,7	1,0	3,1	88,3	1001,6	2,1	7,3	2	2		0	0	0	
3409	ar	man	dagur	klst	t	td	d	f	n	v	p	nh	h	snc	sncm	r	rn	sl	sn	
2001	2	5	3	-3,0	-9,8	90	5,7	0	89	1013,2	9	0	4				0	0	0	
2001	2	5	6	-3,5	-9,7	80	6,2	0	89	1012,0	9									
2001	2	5	9	-3,6	-9,8	40	1,5	0	89	1011,0	9									
2001	2	5	12	-1,9	-8,2	120	4,6	1	89	1009,6	1	7								
2001	2	5	15	0,2	-8,0	60	5,1	1	89	1008,8	1	7								
2001	2	5	18	-0,1	-8,9	80	3,6	1	89	1009,3	1	6								
2001	2	5	21	-3,3	-9,8	110	2,1	1	89	1009,5	1	9								
2001	2	5	24	-3,7	-11,4	100	2,1	2	89	1009,1	1	9								
2001	2	6	3	-5,4	-10,6	70	1,0	2	89	1008,4	2	9	0	4			0	0	0	
2001	2	6	6	-3,2	-10,7	40	2,1	6	89	1007,3	2	8								
2001	2	6	9	-2,2	-13,2	60	4,1	2	89	1007,3	1	6								
2001	2	6	12	-0,9	-9,8	70	3,1	1	89	1007,8	1	6								
2001	2	6	15	-0,2	-7,3	360	2,1	1	82	1006,6	1	5								
2001	2	6	18	-1,5	-8,5	50	3,1	1	88	1006,6	1	5								
2001	2	6	21	-1,8	-7,6	30	6,7	1	89	1006,3	1	6								
2001	2	6	24	-2,7	-8,5	30	4,6	1	89	1006,4	1	8								
average 09 - 09																				
					-2,5	-10,1	80,0	3,1	2,0	89,0	1008,7	1,3	7,6	0	4		0	0	0	

2002																			
3578	year	month	day	hour	t	td	d	f	n	v	p	nh	h	snc	sncm	r	rn	sl	sn
2002	1	21	3	4,0	-4,7	70	5,7	6	86	994,8	2	6	0	2		0	0	0	
2002	1	21	6	4,0	-4,0	80	7,2	6	86	994,6	2	6							
2002	1	21	9	3,7	-6,9	80	6,7	6	89	994,9	3	7							
2002	1	21	12	3,4	-7,8	80	7,2	5	89	995,0	2	9							
2002	1	21	15	3,4	-9,2	100	6,7	6	89	994,4	1	6							
2002	1	21	18	2,3	-9,4	70	5,1	3	89	995,0	2	9							
2002	1	21	21	2,0	-18,9	80	4,6	2	89	996,9	1	9							
2002	1	21	24	0,5	-10,8	60	4,6	0	89	997,5		9							
2002	1	22	3	-1,6	-7,3	30	1,5	0	89	998,2		9	0	2		0	0		
2002	1	22	6	-3,1	-9,5	130	2,1	0	89	998,9		9							
2002	1	22	9	-3,6	-11,8	160	1,5	0	89	1000,1		9							
2002	1	22	12	-4,8	-11,1	90	1,0	1	89	1002,1	1	5							
2002	1	22	15	-5,0	-10,5	100	2,6	1	89	1003,1	1	5							
2002	1	22	18	-5,7	-11,5	70	3,1	1	89	1003,7	1	5							
2002	1	22	21	-5,9	-15,8	70	3,6	0	89	1004,2		9							
2002	1	22	24	-6,2	-13,9	70	3,6	0	89	1005,6		9							
average 09 - 09					0,4	-10,6	88,8	4,2	2,0	89,0	997,0	1,5	8,6	0	2	0	0	0	0
3580	year	month	day	hour	t	td	d	f	n	v	p	nh	h	snc	sncm	r	rn	sl	sn
2002	1	25	3	-4,4	-12,1	90	8,2	6	89	1009,7	2	6	0	2		0	0	0	
2002	1	25	6	-5,3	-11,4	90	8,2	6	89	1007,6	2	9							
2002	1	25	9	-6,7	-13,5	110	6,2	6	89	1006,1	3	9							
2002	1	25	12	-7,0	-15,2	110	7,2	6	86	1003,9	4	9							
2002	1	25	15	-6,3	-16,6	90	6,2	7	84	1000,4	6	8							
2002	1	25	18	-5,9	-15,2	80	6,7	7	86	998,0	6	8							
2002	1	25	21	-4,9	-14,6	60	6,7	8	86	997,3	3	8							
2002	1	25	24	-4,5	-13,3	90	5,7	8	86	995,8	3	8							
2002	1	26	3	-4,0	-13,0	70	4,6	8	89	995,0	3	8	0	2		0	0	0	
2002	1	26	6	-3,6	-13,5	80	4,6	8	89	994,0	3	8							
2002	1	26	9	-3,5	-12,2	100	3,6	7	89	993,9	2	8							
2002	1	26	12	-2,9	-12,8	100	5,1	6	89	994,7	2	8							
2002	1	26	15	-1,7	-11,7	90	4,6	4	89	995,2	2	9							
2002	1	26	18	-3,6	-11,8	70	2,6	2	89	995,8	1	9							
2002	1	26	21	-3,9	-12,3	70	2,6	2	89	996,7	2	9							
2002	1	26	24	-3,7	-13,1	80	3,6	2	89	997,5	2	8							
average 09 - 09					-5,0	-14,2	85,0	5,7	7,4	86,9	997,3	3,8	8,1	0	2	0	0	0	0
3581	year	month	day	hour	t	td	d	f	n	v	p	nh	h	snc	sncm	r	rn	sl	sn
2002	1	27	3	-4,2	-11,7	90	2,6	2	89	998,4	2	9	0	2		0	0	0	
2002	1	27	6	-5,7	-13,1	80	2,1	2	89	999,0	2	9							
2002	1	27	9	-5,4	-12,0	80	3,1	1	89	999,5	1	7							
2002	1	27	12	-4,9	-14,6	100	5,1	0	89	1000,4		9							
2002	1	27	15	-4,4	-13,1	100	4,6	1	89	998,8	1	9							
2002	1	27	18	-6,1	-15,5	110	3,6	1	89	997,8	1	5							
2002	1	27	21	-6,9	-11,7	90	4,1	1	89	997,0	1	9							
2002	1	27	24	-9,1	-18,1	150	1,0	1	89	996,6	1	9							
2002	1	28	3	-9,4	-16,5	90	0,5	0	89	996,2		9	0	2		0	0	0	
2002	1	28	6	-10,6	-18,4	90	1,5	0	89	997,7		9							
2002	1	28	9	-9,7	-15,6	60	3,1	0	89	1000,0		9							
2002	1	28	12	-7,8	-17,2	80	3,6	1	89	1002,7	0	9							
2002	1	28	15	-6,0	-18,2	110	2,6	1	89	1004,4	0	9							
2002	1	28	18	-7,4	-15,2	80	4,1	1	89	1005,5	0	9							
2002	1	28	21	-8,0	-17,6	90	2,6	0	89	1006,4		9							
2002	1	28	24	-6,5	-17,0	90	4,6	1	89	1006,6	1	9							
average 09 - 09					-7,6	-15,4	98,8	2,9	0,5	89,0	998,1	1,0	9	0	2	0	0	0	0

3603	year	month	day	hour	t	td	d	f	n	v	p	nh	h	snc	sncr	r	rn	sl	sn
	2002	3	18	3	-4,1	-10,6	80	4,1	1	89	1014,3	1	6	0	4		0	0	0
	2002	3	18	6	-5,4	-12,6	80	3,6	1	89	1013,6	1	9						
	2002	3	18	9	-5,4	-13,1	90	4,1	1	89	1014,3	1	9						
	2002	3	18	12	-2,9	-12,2	90	4,6	1	89	1014,4	1	9						
	2002	3	18	15	-2,0	-11,2	70	4,1	1	89	1014,1	1	9						
	2002	3	18	18	-0,6	-10,3	130	1,5	0	89	1013,6		9						
	2002	3	18	21	-1,1	-1,2	80	3,6	0	89	1013,9		9						
	2002	3	18	24	-6,6	-14,5	100	3,1	0	89	1013,6		9						
	2002	3	19	3	-7,1	-16,0	90	2,1	0	89	1013,0		9	0	4		0	0	0
	2002	3	19	6	-7,0	-12,9	90	1,5	5	89	1012,2	5	5						
	2002	3	19	9	-6,9	-10,7	80	1,5	2	89	1012,5	1	6						
	2002	3	19	12	-1,7	-7,9	30	2,6	7	88	1012,1	6	5						
	2002	3	19	15	-1,8	-8,0	30	3,6	7	87	1012,1	7	5						
	2002	3	19	18	-1,2	-6,8	20	2,6	7	86	1011,7	7	5						
	2002	3	19	21	-1,0	-6,1	40	2,6	8	89	1012,1	8	5						
	2002	3	19	24	-0,7	-4,2	60	2,1	8	88	1012,5	8	5						
average 09 - 09					-4,3	-11,1	91,3	2,8	1,1	89,0	1013,4	2,0	6,1	0	4	0	0	0	0
3604	year	month	day	hour	t	td	d	f	n	v	p	nh	h	snc	sncr	r	rn	sl	sn
	2002	3	20	3	-1,1	-3,4	10	2,1	8	75	1012,6	7	4	0	4	0,1	0	0	1
	2002	3	20	6	-1,2	-3,2	60	2,6	8	80	1012,8	7	4						
	2002	3	20	9	-0,8	-5,8	70	3,1	8	84	1013,7	7	5						
	2002	3	20	12	0,1	-5,3	80	4,1	7	89	1013,8	6	6						
	2002	3	20	15	1,1	-4,6	70	4,1	7	88	1014,1	6	6						
	2002	3	20	18	0,8	-5,4	80	5,1	7	82	1013,7	6	5						
	2002	3	20	21	-0,3	-6,2	80	5,7	7	86	1014,1	7	7						
	2002	3	20	24	-1,3	-6,9	90	6,7	2	87	1013,5	2	7						
	2002	3	21	3	-1,2	-6,8	70	6,2	7	89	1013,4	6	7	0	2	0,0	0	0	0
	2002	3	21	6	-0,1	-5,9	80	5,7	7	89	1013,0	2	5						
	2002	3	21	9	1,1	0,6	80	5,1	6	89	1013,3	2	5						
	2002	3	21	12	3,8	-5,4	90	7,7	6	89	1013,7	0	8						
	2002	3	21	15	5,2	-3,8	90	5,7	5	89	1014,5	2	5						
	2002	3	21	18	4,0	-3,2	90	6,2	6	86	1014,2	2	5						
	2002	3	21	21	2,5	-3,5	90	4,1	4	87	1014,8	4	5						
	2002	3	21	24	2,7	-4,7	90	4,6	6	87	1015,8	5	6						
average 09 - 09					0,0	-5,1	78,8	5,3	6,3	87,4	1013,6	4,6	6,0	0	3	0	0	0	0

Annex III - Results from ICP-OES and ICP-MS analysis

Conc. (%)			Na	Mg	Al	Ca	Mn	Fe	Zn	Ba	Co	Cu	Nb	Pb	Sr	Ti	V	Zr
			%	%	%	%	%	%	%	ppm	ppm	ppm	ppm	ppm	ppm	ppm	ppm	ppm
MAX			42	5	13	8	69	8	1	11014	88228	18596	1028	9823	6016	9099	436	745
MIN			0,06	0,00	0,00	0,00	0,00	0,00	0,00	0	0	0	0	0	0	0	0	0
Soil A - 27	G	LS27	0,38	0,38	6,55	0,76	0,14	9,67	0,18	55	48	181	57	17,3	67	15683	406	253
Soil A - 28	F	LS28	0,35	0,29	5,73	0,74	0,15	8,66	0,09	64	218	956	349	128,7	88	15873	424	473
Soil A - 29	G	LS29	0,04	0,10	2,57	0,15	0,06	4,01	0,01	16	22	74	7	5,0	18	6345	176	48
Soil A - 30	F	LS30	0,20	0,29	6,44	0,51	0,31	9,44	0,17	45	104	239	31	33,5	62	15603	453	117
Soil B - 31	G	LS31	0,09	0,29	6,41	0,54	0,07	7,67	0,13	60	28	144	16	17,8	53	16260	425	101
Soil B - 32	F	LS32	0,18	0,13	4,07	0,52	0,10	4,30	0,23	34	336	308	-8	101,4	20	10240	180	93
Soil B - 33	G	LS33	0,07	0,24	6,35	0,40	0,05	7,16	0,03	55	33	140	8	15,8	39	14388	398	144
Soil B - 34	F	LS34	0,40	0,45	7,98	0,98	0,05	7,78	0,36	84	87	315	92	14,1	84	19066	463	447
Soil C - 35	G	LS35	0,11	0,47	4,59	0,89	0,00	4,62	0,12	59	52	268	0	50,2	70	9591	256	83
Soil C - 37	G	LS37	0,35	1,39	5,12	1,86	0,08	6,13	0,02	42	78	275	122	13,9	166	7951	152	116
Soil C - 38	F	LS38	0,49	1,02	5,21	1,30	0,12	4,73	0,12	21	222	297	270	44,2	124	5220	-8	304
Soil C - 39	G	LS39	0,54	1,55	5,60	2,57	0,09	6,55	0,03	39	48	464	31	22,0	189	8380	167	84
Soil C - 40	F	LS40	0,27	1,13	3,91	1,63	0,00	4,33	0,05	7	40	137	0	58,8	114	4564	31	54
Brakel. - 41	G	LS41	0,59	1,30	1,35	3,39	0,16	22,0	0,89	35091	32	1959	9	485	536	1740	58	62
Brakel. - 42	F	LS42	0,71	1,13	2,81	2,86	0,15	19,4	1,05	24423	109	3513	36	557	411	1370	25	125
Brakel. - 43	G	LS43	0,56	1,26	0,98	3,46	0,16	21,0	0,98	37660	25	1959	8	505	553	959	33	63
Brakel. - 61	G	LS61	0,60	1,25	1,27	3,51	0,16	21,8	0,96	35170	23	2418	10	509	545	1100	50	72
Brakel. - 62	F	LS62	0,35	0,85	0,85	2,67	0,14	16,6	0,83	25521	94	3153	56	476	413	711	29	91
Diesel - 45	G	LS45	0,59	1,08	2,62	2,46	0,16	12,49	0,88	31311	0	3192	558,9	431,2	491	3275	0	328
Diesel - 46	F	LS46	0,32	0,53	2,42	1,00	0,05	2,15	0,79	4943	0	8426	715,8	512,0	373	0	0	396
Diesel - 47	G	LS47	0,68	1,41	2,66	3,38	0,15	16,67	0,96	42050	0	5006	12,1	560,3	594	3157	0	60
Gasoline -51	G	LS51	1,10	0,93	2,33	2,75	0,13	12,21	0,82	29620	0	6259	0,0	533	462	0	0	0
Gasoline -52	F	LS52	0,06	0,57	2,14	1,07	0,01	2,89	0,78	1603	0	10767	0,0	1566	0	0	0	0
Asphalt - 57	G	LS57	0,85	0,89	4,49	3,00	0,07	5,47	0,12	840	9	133	-0,1	13,1	28	627	25	11
Asphalt - 58	F	LS58	0,56	0,43	2,34	1,88	0,08	3,75	0,27	343	-7	390	-5,0	28,2	15	260	26	12
Asphalt - 59	G	LS59	1,00	0,89	4,81	3,18	0,06	4,80	0,07	278	14	166	44,1	9,5	26	773	30	48
Asphalt - 60	F	LS60	0,65	0,50	3,18	2,21	0,06	3,05	0,19	100	32	442	39,6	26,4	18	459	20	35
Sea-salt	G		30	3,9	0,0	1,1	0,0	0,0	0,0	0,9	0,0	0,1	0,0	0,0	231,4	0,0	0,1	0,0
Sea-salt	F		30	3,9	0,0	1,1	0,0	0,0	0,0	0,9	0,0	0,1	0,0	0,0	231,4	0,0	0,1	0,0

Conc. (%)			Na	Mg	Al	Ca	Mn	Fe	Zn	Ba	Co	Cu	Nb	Pb	Sr	Ti	V	Zr
			%	%	%	%	%	%	%	ppm	ppm	ppm	ppm	ppm	ppm	ppm	ppm	ppm
2720G	G	LS01	5,08	2,06	5,62	3,12	0,06	3,82	0,04	67	98	253	11	70	122	3172	109	37
2720F	F	LS02	41,8	5,03	0,17	1,91	0,00	0,00	0,02	0	84	115	0	27	216	0	0	0
2733G	G	LS03	2,73	3,26	7,96	7,53	0,15	8,23	0,05	120	72	317	91	44	201	9099	292	207
2733F	F	LS04	1,24	1,75	4,57	3,38	0,07	4,59	0,03	58	43	278	0	43	109	4073	156	30
3018G	G	LS05	1,67	1,46	5,68	4,07	0,27	4,67	0,04	184	296	393	15	55	169	4506	156	59
3018F	F	LS06	1,92	0,50	1,44	1,16	1,80	1,58	0,10	381	2372	649	0	220	174	0	0	0
3013G	G	LS07	2,42	1,26	4,44	3,28	0,31	4,18	0,06	278	351	510	0	95	156	3703	148	35
3013F	F	LS08	1,70	0,39	1,54	1,23	1,63	1,86	0,10	456	2143	1211	0	557	163	0	152	0
3054G	G	LS09	1,96	0,78	4,47	2,17	1,03	2,62	0,06	184	1375	391	0	55	163	2241	150	0
3054F	F	LS10	8,23	0,45	1,07	0,67	1,85	1,41	0,13	349	2369	414	0	527	149	0	119	0
3069G	G	LS11	4,54	1,51	5,32	3,92	0,34	4,77	0,04	195	377	422	0	60	174	4566	175	34
3069F	F	LS12	4,48	0,94	2,73	2,12	2,54	3,00	0,09	517	3315	630	246	445	248	0	0	166
3294G	G	LS13	3,41	1,36	4,30	2,60	0,75	4,95	0,05	168	895	416	0	0	226	7818	162	80
3294F	F	LS14	2,15	1,10	4,01	2,03	3,47	3,75	0,05	0	4170	1187	0	0	244	5406	0	0
3321G	G	LS15	10,23	1,74	13,41	4,02	14,07	5,86	0,23	994	18175	1815	0	0	1051	0	0	0
3321F	F	LS16	11,03	1,00	12,87	6,53	68,72	4,05	0,47	0	88228	18596	0	0	4137	0	0	0
3392G	G	LS17	4,45	1,58	5,56	4,35	0,68	5,43	0,05	541	777	847	0	198	229	4521	186	54
3392F	F	LS18	2,08	0,39	2,22	1,46	3,28	3,35	0,14	977	4281	1922	0	1107	306	0	0	0
3297G	G	LS19	5,45	1,00	2,63	1,93	6,44	1,82	0,54	221	8136	0	1028	0	517	0	0	655
3297F	F	LS20	3,72	0,17	5,76	1,03	11,03	1,15	0,13	0	15985	0	0	0	1005	0	0	0
3307F	F	LS21	9,67	1,26	1,24	0,61	2,87	0,44	0,12	0	3925	0	0	0	335	0	0	0
3307G	G	LS22	6,22	1,09	1,50	1,41	1,18	1,38	0,03	66	1428	0	0	0	147	0	0	0
3409G	G	LS23	1,49	1,50	5,70	4,00	0,50	4,86	0,04	129	603	300	0	44	176	4722	181	36
3409F	F	LS24	2,21	1,04	6,22	3,17	12,02	4,14	0,17	402	16420	0	0	0	851	0	0	0
3042G	G	LS63	2,35	1,48	3,47	2,35	0,40	4,21	0,10	3592	399	1361	0	1524	1574	2694	112	0
3042F	F	LS64	0,91	1,90	1,03	0,28	1,01	0,63	0,56	11014	1310	2882	0	9823	6016	0	0	63
3371G	G	LS65	0,06	0,02	0,09	0,09	0,24	0,43	0,02	191	291	199	0	78	28	0	0	0
3371F	F	LS66	0,29	0,00	1,10	0,00	2,19	2,04	0,33	1063	3310	2479	0	1460	280	0	0	0
3388G	G	LS67	4,28	1,12	3,50	2,61	0,11	4,01	0,05	247	93	452	59	76	128	3627	157	98
3388F	F	LS68	1,83	0,60	8,98	1,42	0,71	2,14	0,08	233	883	460	55	142	123	1330	81	73
3578G	G	LS69	1,42	1,18	4,27	2,78	0,05	4,14	0,06	172	53	649	0	54	133	4372	168	35
3578F	F	LS70	2,85	1,13	6,77	2,63	0,00	3,44	0,38	607	0	4330	0	385	0	0	0	0
3580G	G	LS71	1,22	1,32	5,25	2,95	0,08	5,16	0,11	216	128	959	0	59	143	5482	181	0
3580F	F	LS72	2,00	1,19	7,95	2,51	0,00	4,27	0,54	323	0	4942	0	418	158	0	0	0
3581G	G	LS73	1,28	1,23	4,10	2,72	0,05	4,23	0,06	207	62	583	0	67	131	4123	159	38
3581F	F	LS74	1,88	0,62	2,56	1,56	0,00	2,52	0,19	486	421	2527	0	312	95	3976	195	0
3593G	G	LS75	6,37	1,18	4,03	2,85	0,05	4,11	0,06	231	151	476	0	67	150	4166	184	27
3593F	F	LS76	7,09	1,16	3,38	2,05	0,00	3,61	0,78	493	471	2642	0	479	222	2801	0	0
3594G	G	LS77	8,31	1,40	4,55	3,41	0,06	4,42	0,26	415	0	935	0	98	182	4182	187	0
3594F	F	LS78	5,56	0,77	2,52	1,33	0,00	2,57	0,48	801	0	1187	0	658	151	0	436	0
3602G	G	LS79	2,85	1,09	4,31	2,87	0,04	3,88	0,05	208	104	409	0	61	150	4187	203	0
3602F	F	LS80	2,47	1,13	5,50	2,34	0,05	3,51	0,08	222	272	594	0	170	161	4049	214	0
3603G	G	LS81	1,92	1,13	3,44	2,46	0,05	4,01	0,05	216	35	457	185	61	127	3681	160	200
3603F	F	LS82	2,69	0,66	2,59	1,85	0,00	3,05	0,32	764	0	4386	634	550	152	2310	0	745
3604G	G	LS83	5,46	1,16	4,10	2,99	0,06	4,02	0,04	203	53	390	45	54	154	4259	173	78
3604F	F	LS84	4,04	0,78	3,70	1,95	0,00	3,21	0,17	824	0	1454	439	365	178	0	0	457

Annex IV - Results from statistical analysis

Results for statistical analysis for PMcoarse samples.

Coarse 5	Soil	Asphalt	Brakelining	Soot	Salt	Total
Name	Predict	Predict	Predict	Predict	Predict	%
Soil A - 27	1,00	-0,02	-0,07	0,02	0,00	93
Soil B - 31	1,04	-0,04	-0,09	0,03	-0,01	92
Soil B - 33	0,94	0,09	-0,06	-0,02	-0,01	94
Brakelining - 41	0,00	0,09	0,95	0,00	-0,04	100
Brakelining - 43	-0,06		0,99	0,02	-0,05	91
Brakelining - 61	-0,03	0,10	0,94	0,04	-0,04	100
Diesel - 45	0,06	0,03	0,06	0,83	0,01	99
Diesel - 47	0,03	-0,21	0,18	0,96	-0,01	95
Gasoline -51	-0,06	0,08	-0,19	1,15		99
Asphalt - 57		0,95				95
Asphalt - 59		0,95				95
Salt	0,00		0,08	0,02	0,99	109
3069G	0,32	0,49	0,02	0,05	0,16	104
3294G	0,47	0,32	-0,38	0,47	0,16	103
3392G	0,33	0,41	-0,10	0,23	0,16	102
3307G						0
3409G	0,33	0,58	-0,03	0,09	0,08	106
3371G		0,98				98
3388G	0,27	0,54	0,03	0,04	0,16	105
3578G	0,31	0,60	0,04	0,04	0,08	106
3580G	0,37	0,52	-0,12	0,20	0,07	105
3581G	0,29	0,62	0,07	0,01	0,07	106
3593G	0,32	0,43	0,01	0,05	0,22	102
3594G	0,32	0,30	-0,08	0,19	0,28	101
3602G	0,33	0,53	-0,01	0,07	0,11	104
3603G	0,27	0,62	0,08	0,00	0,09	106
3604G	0,31	0,47	0,01	0,06	0,19	104
Average	0,30	0,53	-0,03	0,11	0,20	97

Results for statistical analysis for PMfine samples.

Fine	Soil	Asphalt	Brakelining	Soot	Salt	Total
Name	Predict	Predict	Predict	Predict	Predict	%
Soil A - 28	0,94	0,03	0,06	0,02	-0,02	103
Soil A - 30	0,96	0,07	0,03	0,00	-0,03	103
Soil B - 34	1,07	-0,08	0,04	0,03	-0,03	103
Brakelining - 42	0,08	0,01	0,95	0,00	0,02	106
Brakelining 44	0,03	-0,08	1,09		0,02	105
Brakelining - 62	0,03	0,10	0,93	-0,02	0,01	106
Diesel- 46	-0,01	-0,01	0,05	0,87	0,02	92
Gasoline -52	-0,03	0,01	-0,03	1,10	-0,02	103
Asphalt - 56	0,02	0,97	0,00	-0,01	0,02	99
Asphalt- 58	0,02	1,00	-0,02	-0,02	0,00	99
Asphalt - 60	0,02	1,00	-0,03	-0,02	0,01	99
Salt					1,00	100
3054F	0,09	0,36	-0,04	0,30	0,24	95
3069F	-0,03	0,43	-0,03	0,42	0,15	94
3392F	-0,01	0,12	0,02	0,76	0,07	96
3294F	0,11	0,42	-0,14	0,44	0,08	92
3307F						
3371F	0,00	0,03	0,04	0,91		98
3388F	0,23	0,70	0,05	-0,05	0,05	98
3578F	0,00	0,62	-0,05	0,35	0,07	99
3580F	0,07	0,45	0,06	0,33	0,07	98
3581F	0,30	0,42	0,01	0,22	0,05	99
3594F	0,41	0,02	0,05	0,36	0,16	100
3593F	0,06	0,21	0,05	0,41	0,22	95
3602F	0,36	0,43	0,05	0,06	0,09	98
3603F	0,07	0,41	0,05	0,37	0,09	98
3604F	-0,02	0,50	-0,04	0,40	0,12	95
AVG(%)	0,12	0,37	0,01	0,38	0,11	97

Results for Brake lining was taken out of the collection. All figures below plus/minus 0,5 were deleted. The result is shown in following table for PMfine.

Sirius Report					
Fine	Soil	Asphalt	Soot	Salt	Total
Name	Predict	Predict	Predict	Predict	%
Soil A - 28	0,94	0,03	0,02	-0,02	97
Soil A - 30	0,96	0,07	0,00	-0,03	100
Soil B - 34	1,07	-0,08	0,03	-0,03	99
Brakelining - 42	0,08	0,01	0,00	0,02	12
Brakelining 44	0,03	-0,08		0,02	-4
Brakelining - 62	0,03	0,10	-0,02	0,01	13
Diesel- 46	-0,01	-0,01	0,87	0,02	87
Gasoline -52	-0,03	0,01	1,10	-0,02	106
Asphalt - 56	0,02	0,97	-0,01	0,02	99
Asphalt- 58	0,02	1,00	-0,02	0,00	100
Asphalt - 60	0,02	1,00	-0,02	0,01	101
Salt				1,00	100
3054F	0,09	0,36	0,30	0,24	99
3069F		0,43	0,42	0,15	100
3294F	0,11	0,42	0,44	0,08	105
3307F					
3371F			0,91		91
3388F	0,23	0,70			93
3392F		0,12	0,76	0,07	95
3409					
3578F		0,62	0,35	0,07	104
3580F	0,07	0,45	0,33	0,07	92
3581F	0,30	0,42	0,22	0,05	98
3593F	0,06	0,21	0,41	0,22	90
3594F	0,41		0,36	0,16	93
3602F	0,36	0,43	0,06	0,09	93
3603F	0,07	0,41	0,37	0,09	93
3604F		0,50	0,40	0,12	102
					96
Average	0,19	0,42	0,41	0,12	1,14

Results for Brake lining was taken out of the collection. All figures below plus/minus 0,5 were deleted. The result is shown in following table for PMcoarse. Sample 3294G has over 140% mass total which is regarded as unacceptable.

Coarse 5	Soil	Asphalt	Soot	Salt	Total
Name	Predict	Predict	Predict	Predict	%
Soil A - 27	1,00	-0,02	0,02	0,00	100
Soil B - 31	1,04	-0,04	0,03	-0,01	102
Soil B - 33	0,94	0,09	-0,02	-0,01	100
Brakelining - 41	0,00	0,09	0,00	-0,04	5
Brakelining - 43	-0,06		0,02	-0,05	-9
Brakelining - 61	-0,03	0,10	0,04	-0,04	6
Diesel - 45	0,06	0,03	0,83	0,01	93
Diesel - 47	0,03	-0,21	0,96	-0,01	77
Gasoline -51	-0,06	0,08	1,15		118
Asphalt - 57		0,95			95
Asphalt - 59		0,95			95
Salt	0,00		0,02	0,99	101
3069G	0,32	0,49	0,05	0,16	102
3294G	0,47	0,32	0,47	0,16	141
3392G	0,33	0,41	0,23	0,16	112
3307G					
3409G	0,33	0,58	0,09	0,08	108
3371G		0,98			98
3388G	0,27	0,54		0,16	97
3578G	0,31	0,60		0,08	99
3580G	0,37	0,52	0,20	0,07	117
3581G	0,29	0,62		0,07	98
3593G	0,32	0,43		0,22	96
3594G	0,32	0,30	0,19	0,28	109
3602G	0,33	0,53	0,07	0,11	105
3603G	0,27	0,62		0,09	99
3604G	0,31	0,47	0,06	0,19	103
Average	0,30	0,53	0,15	0,20	106

Illustration of the results from statistical analysis, showing mass fraction of each source material :

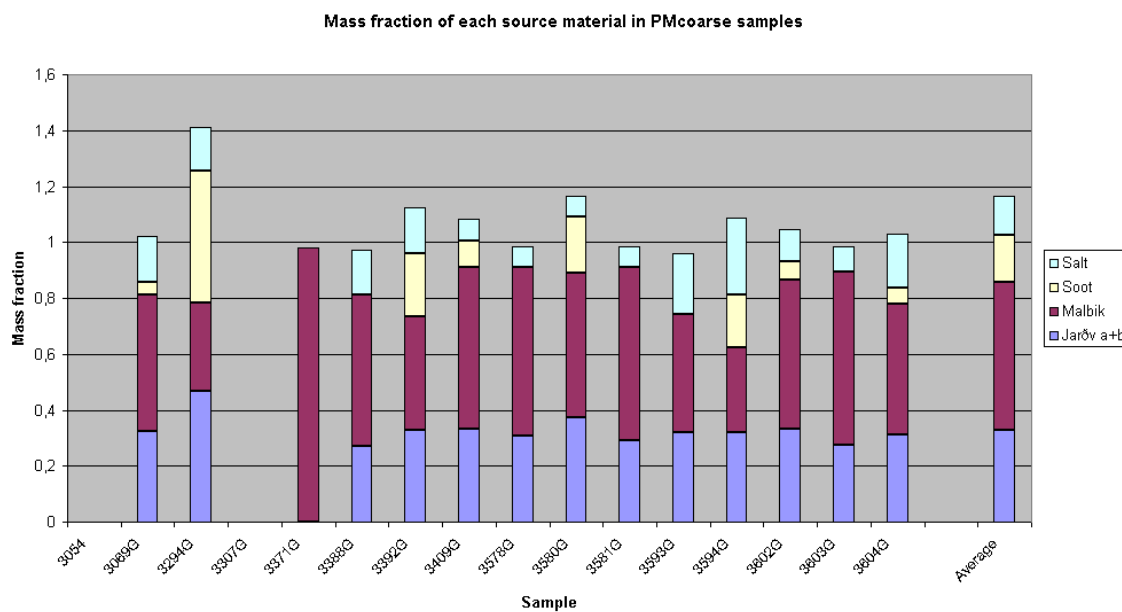

Mass fraction of each source material in PMcoarse samples

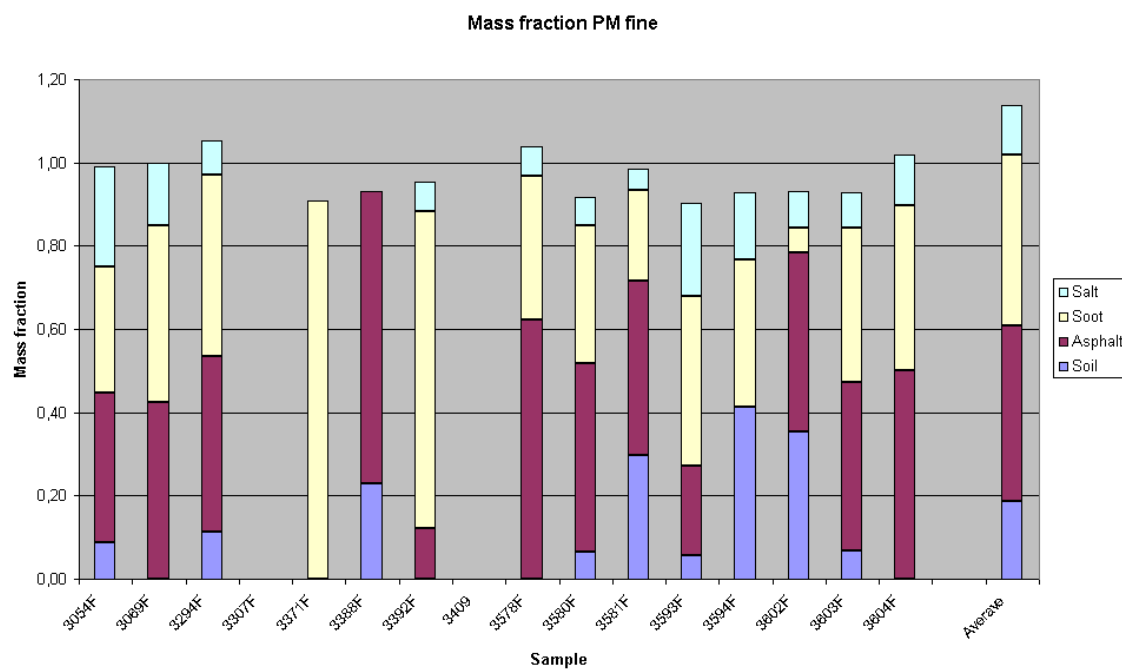

Mass fraction of each source material in PMfine samples

TECHNICAL REPORTS – LIFE SCIENCE AND BIOTECHNOLOGY

Notice: Only technical reports with a bold number on the left leaf of the page can be ordered free of charge from the Nordtest secretariat. Others have to be ordered from the publishing organisation or institute. Information for ordering those reports can be obtained from Nordtest secretariat and Nordtest Web-site.

- 381** Winding, A., Kvaløy, K., Bohse Hendriksen, N., Gustafsson, K., Iversen, T.-G., Helgason, E. & Kolstø, A.-B., Procedures for risk identification and assessment of genetically modified microorganisms. Espoo 1998. Nordtest, NT Techn Report 381. 60 p. NT Project No. 1335-97.
- 398** Report from workshop on risk assessment, with special focus on genetically modified plants. Espoo 1998. Nordtest, NT Techn Report 398. 146 p. NT Project No. 1375-98.
- 406** Komppa, V., Jensen, V., Järvinen, O., Månsson, M. & Saeed, K., A Nordic network of environmental chemical reference laboratories. Espoo 1998. Nordtest, NT Techn Report 406. 41 p. NT Project No. 1307-96.
- 408 Tiberg, E., Nordic reference soils. Copenhagen 1998. Nordic Council of Ministers, TemaNord 1998:537. 106 p. NT Project No. 1336-96.
- 409** Rognli, O.A., Tomiuk, J., Tufto, J., Nurminiemi, M. & Jørgensen, R.B., Gene flow from transgenic crop plants to wild populations. Espoo 1999. Nordtest, NT Techn Report 409. 42 p. NT Project No. 1348-97.
- 410** Ritala, A., Aikasalo, R., Kauppinen, V. & Tammissola, J., Risk assessment in cultivation of transgenic barley. Espoo 1999. Nordtest, NT Techn Report 410. 7 p. NT Project No. 1376-98.
- 442** Bergström, U. & Jansson, B., Improvements of the method for analysis of chlorinated paraffins. Espoo 1999. Nordtest, NT Techn Report 442. 13 p. NT Project No. 1337-96.
- 454** Skirnisdóttir, S., Hjørleifsdóttir, S., Hreggvidsson, G.O., Kristjánsson, J.K., Torsvik, V. & Holst, O., Sequence based procedures for determining biodiversity in extreme microbial environments. Espoo 2000. Nordtest, NT Techn Report 454. 35 p. NT Project No.1377-98.
- 455** Jansson, J.K., Molin, S. & Romantschuck, M., Test methods for monitoring genetically modified microorganisms (GMMs) in nature. Espoo 2000. Nordtest, NT Techn Report 455. 23 p. NT Project No. 1473-99.
- 479** Vogt, R.D., Gjessing, E., Andersen, D.O, Clarke, N., Gadmar, T., Bishop, K., Lundstrøm, U. & Starr, M., Natural organic matter in the Nordic countries. Espoo 2001. Nordtest, NT Techn Report 479. 150 p. NT Project No. 1472-99.
- 496** Rasmussen, D., Kukkonen, J.V.K., Källqvist, T., Helweg, C., Madsen, T., Mäenpää, K., Sormunen, A. & Efraimsson, H., Distribution, degradation and toxicity of pesticides at environmentally realistic temperatures. Espoo 2002. Nordtest, NT Techn Report 496, 65 p. NT Project No. 1522-01.
- 523** Strandberg, B., Kjær, C., Hindar, K. & Tømmerås, B.Å., Environmental risk assessment of genetically modified organisms (GMOs) - Identification of data needs. Espoo 2003. Nordtest, NT Techn Report 523, 64 p. NT Project No. 1521-01.
- 524** Petersen, G., Rasmussen, D., Mäenpää, K., Källqvist, T., Madsen, T. & Kukkonen, J.V.K., Transport and fate of surfactants in the aquatic environment. Espoo 2003. Nordtest, NT Techn Report 524, 65 p. NT Project No. 1570-02.
- 542** Ritala, A., Teeri, T., Marttila, S. & Rasmussen, S.K., Transgenic raw materials in food production - Detection of transgene and heterologous protein levels. Espoo 2003. Nordtest, NT Techn Report 542, 23 p. NT Project No. 1565-01.
- 544** Skúladóttir, B., Thorlacius, A., Larssen, S. Bjarnason, G.-G. & Þórðarson, H., Method for determining the composition of airborne particle pollution. Espoo 2004. Nordtest, NT Techn Report 544, 53 p. NT Project No. 1571-02.



Nordtest endeavours to

- promote viable industrial development and industrial competitiveness, remove technical barriers to trade and promote the concept “Approved Once Accepted Everywhere” in the conformity assessment area
- work for health, safety, environment in methods and standards
- promote Nordic interests in an international context and Nordic participation in European co-operation
- finance joint research in conformity assessment and the development and implementation of test methods
- promote the use of the results of its work in the development of techniques and products, for technology transfer, in setting up standards and rules and in the implementation of these
- co-ordinate and promote Nordic co-operation in conformity assessment
- contribute to the Nordic knowledge market in the field of conformity assessment and to further development of competence among people working in the field